

## PLAN DE SITUATIE Strada Aviatorilor - sat Deveselu

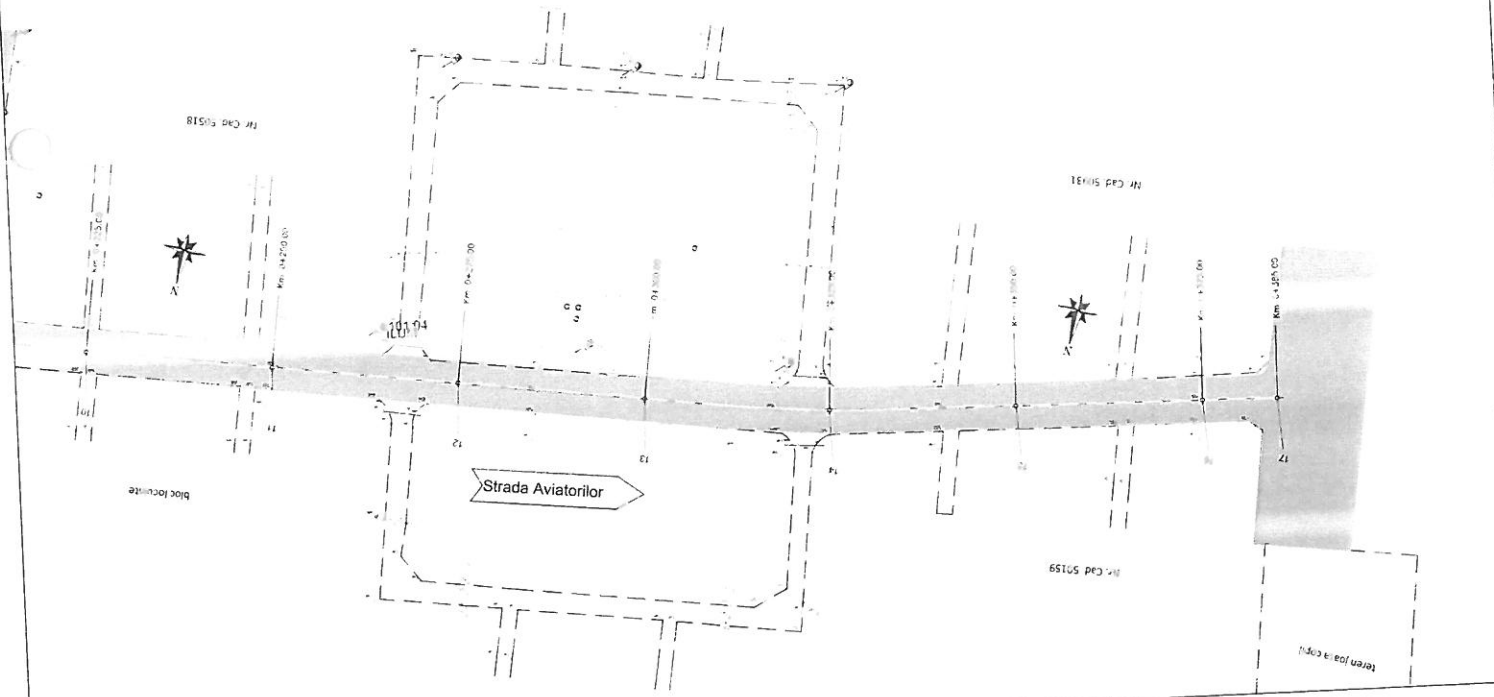

**LEGENDA - elemente proiectate**

- limita carosabil proiectat
- limita acostament proiectat
- limita sant de pământ proiectat
- limita sant de apă proiectat

puțel tubular Ø500 L=7.00m

linia prin construcții

**LEGENDA - elemente existente**

- Măgărie drum
- Linia de alimentare
- Canal
- Staie de pompare

PROIECTANT GENERAL		PROIECTANT DE SPECIALITATE		PETERȘI/EXPERTIZĂRI ȘI SUD	
ING. SUD OLT		ING. SUD OLT		COMUNA DEVESELU, JUDEȚUL OLT	
ING. TRANDAFIR PETRUS		ING. ROȘCĂȘAN CRISTIAN		Asfaltare și modernizare drumuri de interes local, în comuna Deveselu, Județul Olt	
ING. ROȘCĂȘAN CRISTIAN		ING. ROȘCĂȘAN CRISTIAN		S F	
ING. ROȘCĂȘAN CRISTIAN		ING. ROȘCĂȘAN CRISTIAN		PS34	

# PLAN DE SITUATIE

## Strada Aviatorilor - sat Deveselu



**LEGENDA - elemente existente**

- limită drum
- limită paviment
- limită sant
- limită fundație

PROIECTANT GENERAL SOCIETATE	PROIECTANT DE SPECIALITATE SOCIETATE	SCALA 1:500	PROIECTUL DE ASFALTARE SI MODERNIZARE DRUMURI DE INTERES LOCAL IN COMUNA DEVESELU, JUDEȚUL OLT
ING. TRANDAFIR PETIC	ING. RODOLAN CRISTIAN	JULIE 2019	S.F.
ING. RODOLAN CRISTIAN	ING. RODOLAN CRISTIAN		PS35

## PLAN DE SITUATIE Strada Aviatorilor - sat Deveselu

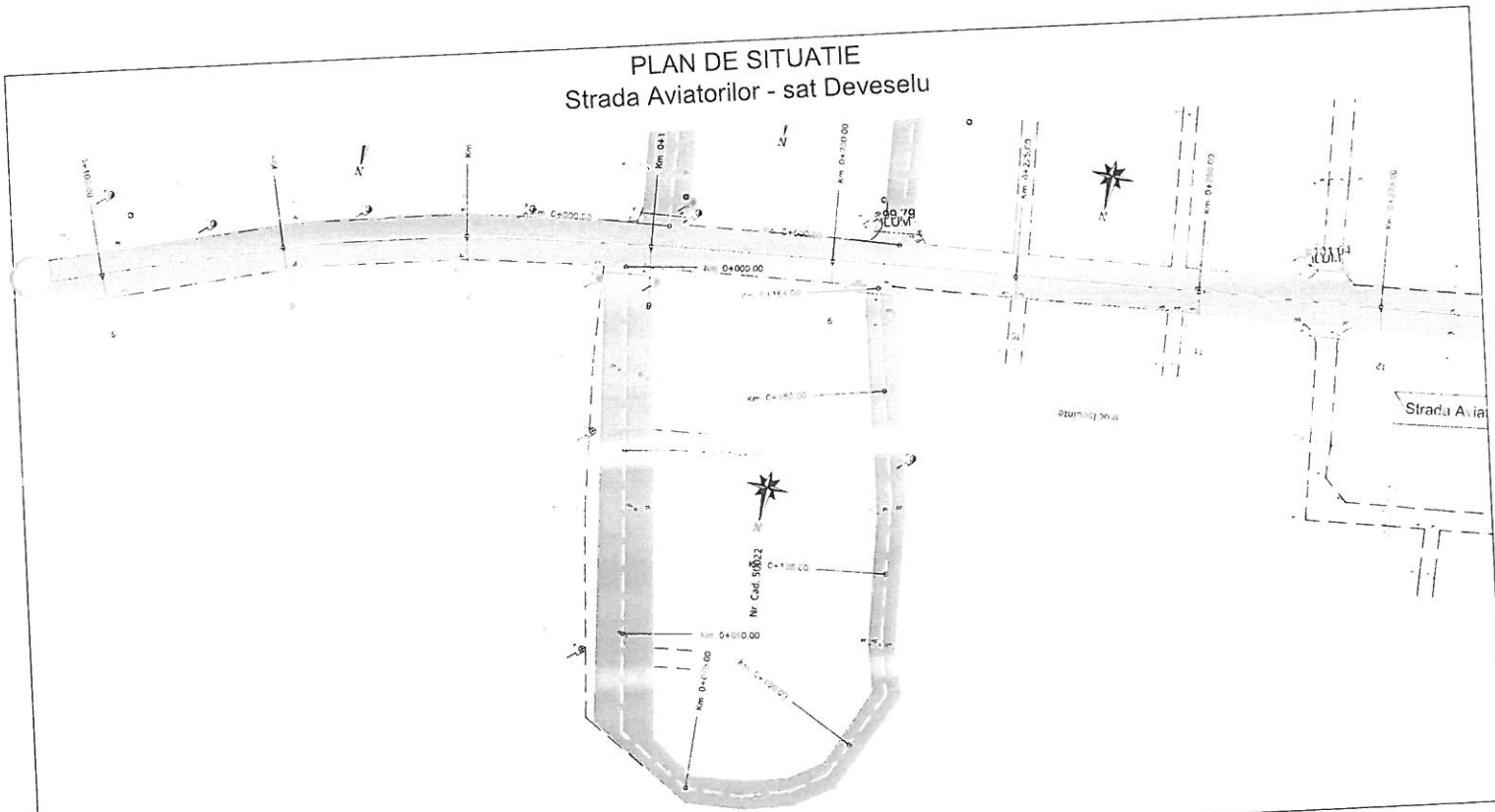

**LEGENDA - elemente proiectate**

- limita carosabil proiectat
- - - limita plantament proiectat
- - - limita sant de pamant proiectat
- - - limita sant de canal proiectat
- model tubular #500, L=7.00m
- limita pota carosabila

**LEGENDA - elemente existente**

- Ax drum
- Margine drum
- Stop & merge

PROIECTANT GENERAL	PROIECTANT DE SPECIALITATE	SCARA	DATA	PROIECT DE PERECHE	PROIECTANT
SCUD OLT	SCUD OLT	1:500	2019	COMUNA DEVESELU, JUDEUL OLT	S.F.
Asfaltare si modernizare drumul de interes local in comuna Deveselu, judetul Olt			10 Iulie 2019	DEPARTAMENTUL DE TRANSPORTURI SI INFRASTRUCTURA	PS36

# PROFIL LONGITUDINAL Strada Aviatorilor - sat Deveselu

K=0+155.89  
 R=5000.00  
 L=100.00  
 P=+1.10  
 m=1.15  
 B=3.05  
 T=6.70

K=0+110.27  
 R=1000.00  
 L=20.00  
 P=-0.14  
 m=1.10  
 B=1.81  
 T=6.46

NR PICHET	DIFERENTE IN AX	COTE PROIECT	RACORDARI VERTICALE	ALINIAMENTE SI CURBE	HECTOMETRII	DISTANTE	DISTANTE CUMULATE
1	+0.50	14.31	L=23.473 P=+2.730%		Km 0+000-000	0.00	0.00
2	+0.10	14.70	R=1000.015 L=20.620	L=117.551 B=274.400	hm 1	23.45	23.45
3	-0.22	14.58	L=65.844			25.00	48.45
4	+0.01	14.00				50.00	98.45
5	-0.21	13.79				75.00	123.45
6	+0.00	13.75	P=+0.99%	L=48.431 R=200.000		100.00	171.88
7	-0.05	13.70				125.00	196.88
8	-0.02	13.65	R=5000.000 L=100.121			135.92	211.80
9	+0.03	13.60				145.00	226.80
10	-0.01	13.55				155.00	241.80
11	-0.09	13.46				165.08	256.88
12	-0.01	13.45				175.00	271.88
13	-0.01	13.45				185.04	286.92
14	-0.00	13.45				195.00	301.92
15	+0.00	13.45				205.00	316.92
16	+0.05	13.40				215.00	331.92
17	+0.05	13.35				225.00	346.92
18	+0.05	13.30				235.00	361.92
19	+0.05	13.25				245.00	376.92
20	+0.05	13.20				255.00	391.92
21	+0.05	13.15				265.00	406.92
22	+0.05	13.10				275.00	421.92
23	+0.05	13.05				285.00	436.92
24	+0.05	13.00				295.00	451.92
25	+0.05	12.95				305.00	466.92
26	+0.05	12.90				315.00	481.92
27	+0.05	12.85				325.00	496.92
28	+0.05	12.80				335.00	511.92
29	+0.05	12.75				345.00	526.92
30	+0.05	12.70				355.00	541.92
31	+0.05	12.65				365.00	556.92
32	+0.05	12.60				375.00	571.92
33	+0.05	12.55				385.00	586.92
34	+0.05	12.50				395.00	601.92
35	+0.05	12.45				405.00	616.92
36	+0.05	12.40				415.00	631.92
37	+0.05	12.35				425.00	646.92
38	+0.05	12.30				435.00	661.92
39	+0.05	12.25				445.00	676.92
40	+0.05	12.20				455.00	691.92
41	+0.05	12.15				465.00	706.92
42	+0.05	12.10				475.00	721.92
43	+0.05	12.05				485.00	736.92
44	+0.05	12.00				495.00	751.92
45	+0.05	11.95				505.00	766.92
46	+0.05	11.90				515.00	781.92
47	+0.05	11.85				525.00	796.92
48	+0.05	11.80				535.00	811.92
49	+0.05	11.75				545.00	826.92
50	+0.05	11.70				555.00	841.92
51	+0.05	11.65				565.00	856.92
52	+0.05	11.60				575.00	871.92
53	+0.05	11.55				585.00	886.92
54	+0.05	11.50				595.00	901.92
55	+0.05	11.45				605.00	916.92
56	+0.05	11.40				615.00	931.92
57	+0.05	11.35				625.00	946.92
58	+0.05	11.30				635.00	961.92
59	+0.05	11.25				645.00	976.92
60	+0.05	11.20				655.00	991.92
61	+0.05	11.15				665.00	1006.92
62	+0.05	11.10				675.00	1021.92
63	+0.05	11.05				685.00	1036.92
64	+0.05	11.00				695.00	1051.92
65	+0.05	10.95				705.00	1066.92
66	+0.05	10.90				715.00	1081.92
67	+0.05	10.85				725.00	1096.92
68	+0.05	10.80				735.00	1111.92
69	+0.05	10.75				745.00	1126.92
70	+0.05	10.70				755.00	1141.92
71	+0.05	10.65				765.00	1156.92
72	+0.05	10.60				775.00	1171.92
73	+0.05	10.55				785.00	1186.92
74	+0.05	10.50				795.00	1201.92
75	+0.05	10.45				805.00	1216.92
76	+0.05	10.40				815.00	1231.92
77	+0.05	10.35				825.00	1246.92
78	+0.05	10.30				835.00	1261.92
79	+0.05	10.25				845.00	1276.92
80	+0.05	10.20				855.00	1291.92
81	+0.05	10.15				865.00	1306.92
82	+0.05	10.10				875.00	1321.92
83	+0.05	10.05				885.00	1336.92
84	+0.05	10.00				895.00	1351.92
85	+0.05	9.95				905.00	1366.92
86	+0.05	9.90				915.00	1381.92
87	+0.05	9.85				925.00	1396.92
88	+0.05	9.80				935.00	1411.92
89	+0.05	9.75				945.00	1426.92
90	+0.05	9.70				955.00	1441.92
91	+0.05	9.65				965.00	1456.92
92	+0.05	9.60				975.00	1471.92
93	+0.05	9.55				985.00	1486.92
94	+0.05	9.50				995.00	1501.92
95	+0.05	9.45				1005.00	1516.92
96	+0.05	9.40				1015.00	1531.92
97	+0.05	9.35				1025.00	1546.92
98	+0.05	9.30				1035.00	1561.92
99	+0.05	9.25				1045.00	1576.92
100	+0.05	9.20				1055.00	1591.92

PROIECTANT GENERAL		PROIECTANT DE SPECIALITATE		COMUNA DEVESELU, JUDEUL OLI	
Ing. Radu Crisan		Ing. Radu Crisan		Asfaltare si modernizare drumuri de interes local in comuna Deveselu, judetul OI	
Ing. Radu Crisan		Ing. Radu Crisan		S.F.	
Ing. Radu Crisan		Ing. Radu Crisan		PL20	

## PROFIL LONGITUDINAL Strada Aviatorilor - sat Deveselu

k=0.000000  
 R=2500.000  
 L=30.000  
 p=0.000000  
 q=0.000000  
 m=1.000  
 B=15.000  
 T=4.51

Cota ref. 101.300	
NR PICHET	15
DIFERENTE IN AX	4.300
PROIECT	15
RACORDARI VERTICALE	R=2500.000 L=30.000
#LINIIMENTE SI CURBE	L=52.117 B=282.673
HECTOMETRII	
DISTANTE	12.99 12.22 2.81 7.19
DISTANTE CUMULATE	12.99 25.21 37.43 44.62

PROIECTANT GENERAL	PROIECTANT DE SPECIALITATE	REPERATIE/VERTICALITATE	PROIECTANT
ING. TUDOR POPESCU	ING. ROBERT CRISTIAN	COMUNA DEVESELU, JUDETLUL OLT	PL.21
ING. ROBERT CRISTIAN	ING. ROBERT CRISTIAN	Asfaltare si modernizare drumuri de interes local, in comuna Deveselu, judetul Olt	S.F
ING. ROBERT CRISTIAN	ING. ROBERT CRISTIAN	Strada Aviatorilor - sat Deveselu	PL.21

## PLAN DE SITUATIE

### Strada Speranta Paunescu - sat Deveselu

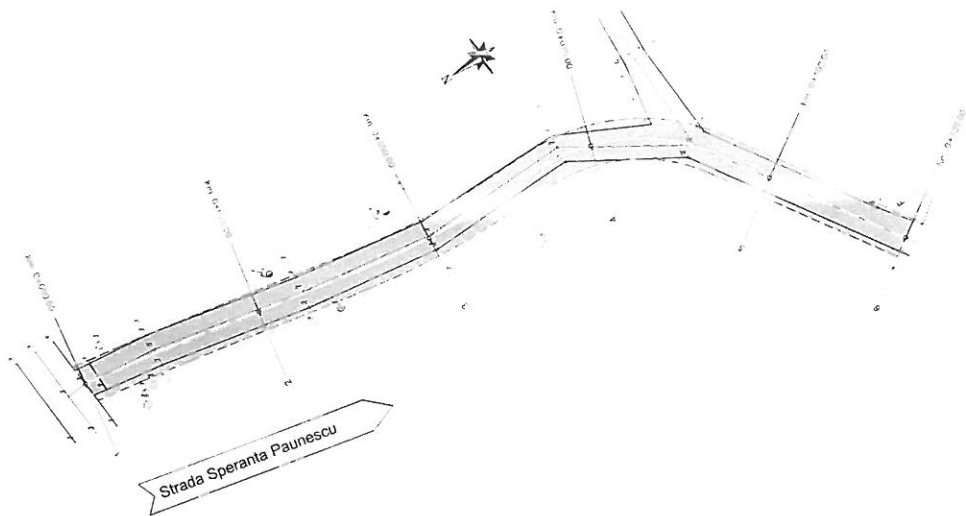

LEGENDA - elemente proiectate	LEGENDA - elemente existente
<p>----- limita carosabil proiectat</p> <p>----- limita acostament proiectat</p> <p>----- limita sant de pamant proiectat</p> <p>----- limita sant de pamant existent</p> <p>----- podul tubular e500, L=7.00m</p> <p>----- limita parter carosabil</p>	<p>----- ax drum</p> <p>----- margini drum</p> <p>----- canal</p> <p>----- trasa electrica</p>

PROIECTANT GENERAL	PROIECTANT DE SPECIALITATE	SCALA	DATA	STADIU	PROIECT	PLAN DE SITUATIE
Ing. Tironelie Petric	Ing. Rodosari Sorinel	1:500	Julie 2019	AS	Astfaltare si modernizare drumuri de interes local in comuna Deveselu, judetul Olt	S.F.
Ing. Rodosari Sorinel	Ing. Rodosari Sorinel					PS37

## PROFIL LONGITUDINAL Strada Speranta Paunescu - sat Deveselu

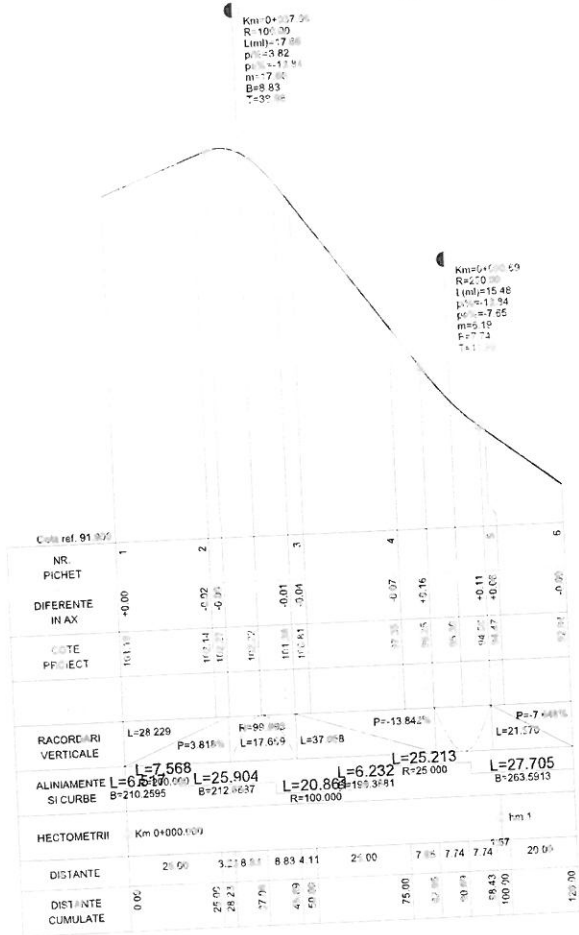

PROIECTANT GENERAL	PROIECTANT DE SPECIALITATE	SCURT TITLU	SCURT TITLU	SCURT TITLU
Ing. Traian Petrică	Ing. Radușan Crăciun	Ing. Radușan Crăciun	Ing. Radușan Crăciun	Ing. Radușan Crăciun
COMUNA DEVESELU, JUDEȚUL OLT		Asfaltare și modernizare drumuri de interes local, în comuna Deveselu, județul Olt		
Iulie 2019		PL.22		







## PLAN DE SITUATIE Strada Mioritei - sat Deveselu

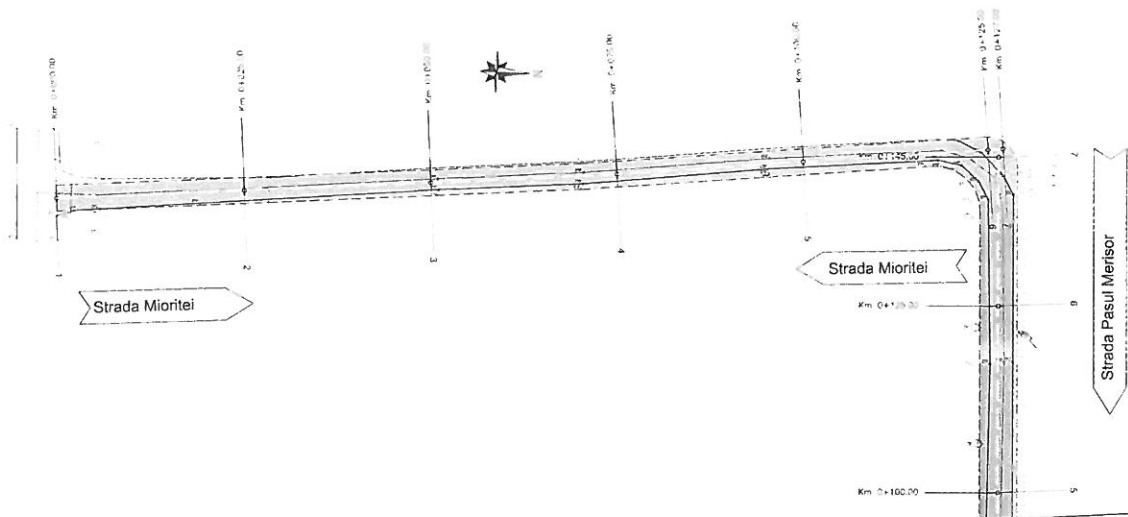

LEGENDA - elemente proiectate	
	limita carosabil proiectat
	linia de aliniament proiectat
	limita sant de panant proiectat
	limita sant perisaj proiectat
	puțuri tubulare #500, L=7.00m
	limita para carosabila

LEGENDA - elemente existente	
	Dr. drum
	Margine drum
	Linii utilitatilor
	Stop electric

PROIECTANT GENERAL	PROIECTANT DE SPECIALITATE	SCALA	DATA	NUMAR
SC SUD OLT	SC SUD OLT	1:500	Iulie 2019	PS39
Ing. Traian Petre Ing. Robert Cioba Ing. Robert Cristian				

Asfaltare și modernizare drumuri de interes local,  
în comuna Deveselu, județul Olt

S.F.  
PS39

## PROFIL LONGITUDINAL Strada Mioritei - sat Deveselu

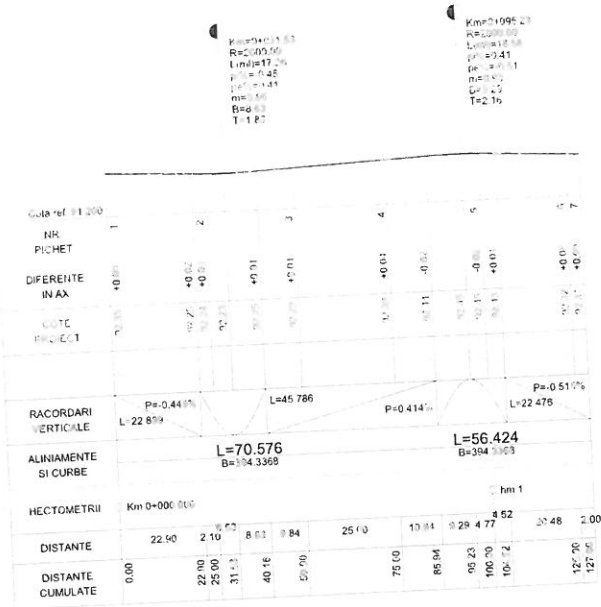

PROIECTANT GENERAL	PROIECTANT DE SPECIALITATE	COMUNA DIVIZIEI ADEPTIVITATI	DATA
Ing. Rodolphe Percec	Ing. Rodolphe Percec	COMUNA DEVESELU	19.07.2019
Ing. Rodolphe Percec	Ing. Rodolphe Percec	COMUNA DEVESELU	19.07.2019
Ing. Rodolphe Percec	Ing. Rodolphe Percec	COMUNA DEVESELU	19.07.2019

**Project Description:** Asfaltare si modernizare drumuri de interes local, in comuna Deveselu, judetul Olt.

**Scale:** 1:50

**Sheet:** PL24

## PLAN DE SITUATIE Strada Gradinilor - sat Deveselu

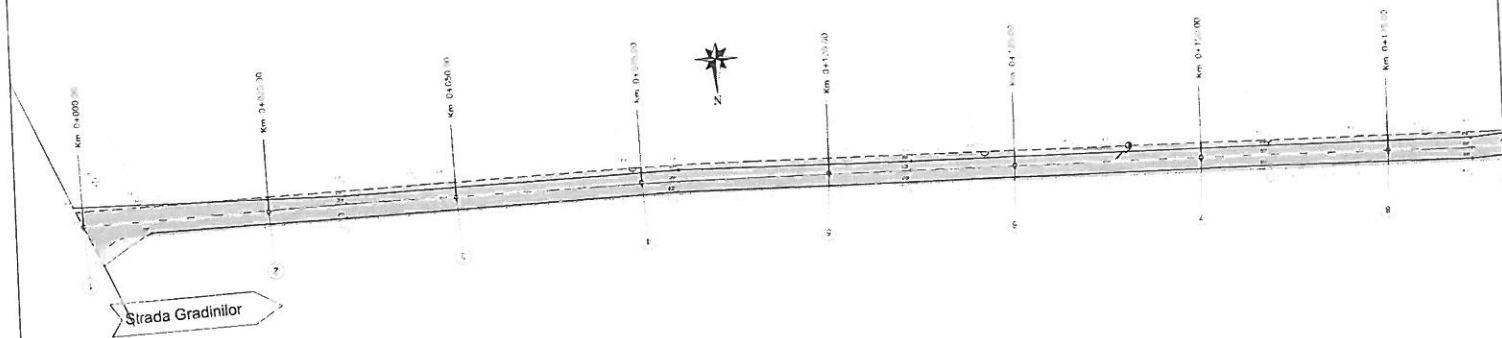

LEGENDA - elemente proiectate	LEGENDA - elemente existente
— limita carosabil proiectat	— linie drum
--- limita acostament proiectat	— Margine drum
— limita sant de pamant proiectat	— linie axa strada
--- limita sant de pamant existent	— linie utilitate
— podet tubular ø500; L=7.00m	— stop #100.00
— limita parbr carosabil	

PROIECTANT GENERAL	PROIECTANT DE SPECIALITATE	REZERVATI/CI PERIODA DE CONSTR	REZERVATI/CI PERIODA DE CONSTR
SC IUD OLT	SC IUD OLT	COMUNA DEVESELU, JUDEUL OLT	COMUNA DEVESELU, JUDEUL OLT
ING. TRANDAFIR PETRIC	ING. RADOLB CRISTIAN	Asfaltare si modernizare drumuri de interes local, in comuna Deveselu, Judetul Olt	S.F.
ING. RADOLB CRISTIAN	ING. RADOLB CRISTIAN	PLAN DE SITUATIE	PS40
ING. RADOLB CRISTIAN		Strada Gradinilor - sat Deveselu	

# PLAN DE SITUATIE

## Strada Gradinilor - sat Deveselu

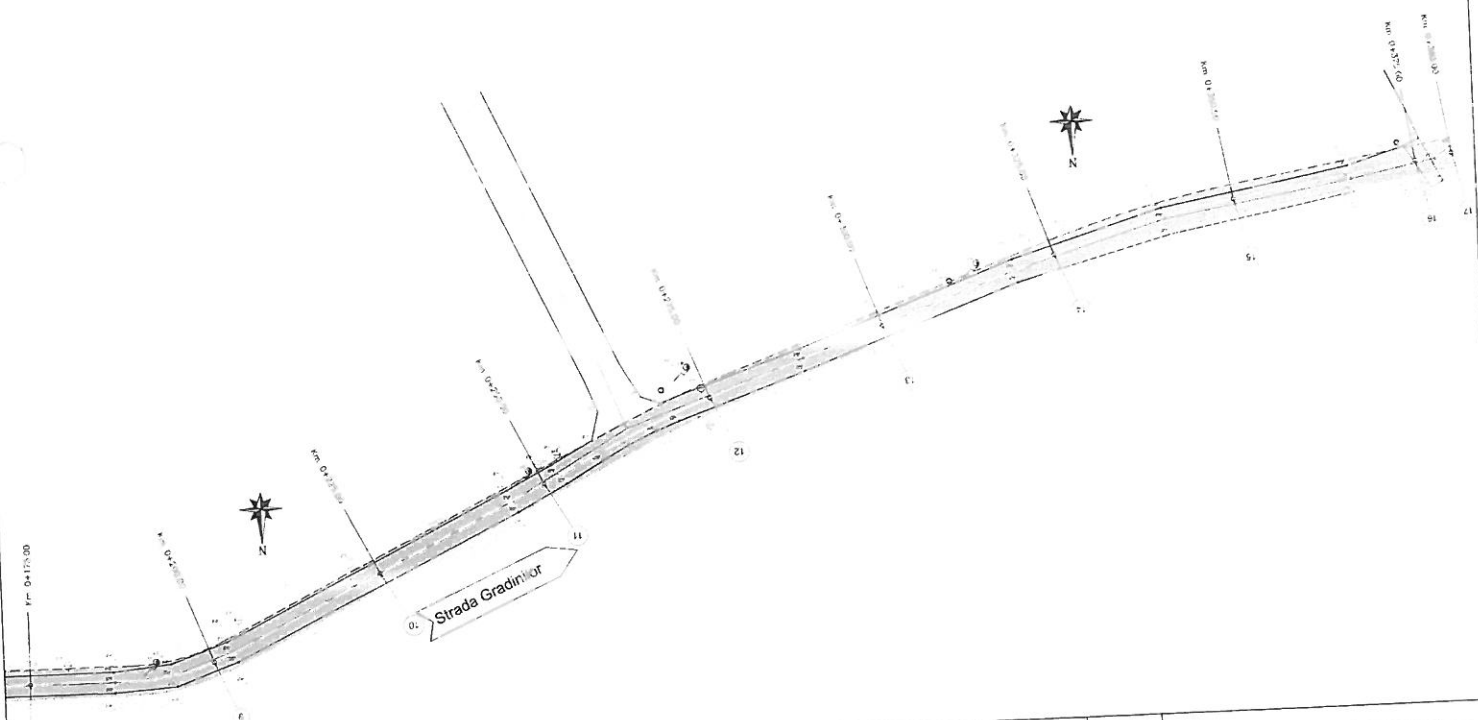

PROIECTANT GENERAL	PROIECTANT DE SPECIALITATE	REVIZUIT/VERIFICAT	CANTONUL DE INGINERII SI ARHITECTURA	S.F.
SC SUD OLT	ING. ROBOTON CRISTIAN	ING. ROBOTON CRISTIAN	COMUNA DE VESELU, JUDEUL OLT	PS41
DATA DATE	DATA DATE	DATA DATE	DATA DATE	DATA DATE
ING. TRANDAFIR PETRIC	ING. ROBOTON CRISTIAN	ING. ROBOTON CRISTIAN	PLANS DE SITUATIE	
ING. ROBOTON CRISTIAN	ING. ROBOTON CRISTIAN	ING. ROBOTON CRISTIAN	Strada Gradinilor - sat Deveselu	
ING. ROBOTON CRISTIAN				

# PROFIL LONGITUDINAL Strada Gradinilor - sat Deveselu

K=+0+162.76  
R=10000.00  
L=100.00  
B=277.71  
P=0.525%  
T=1.19

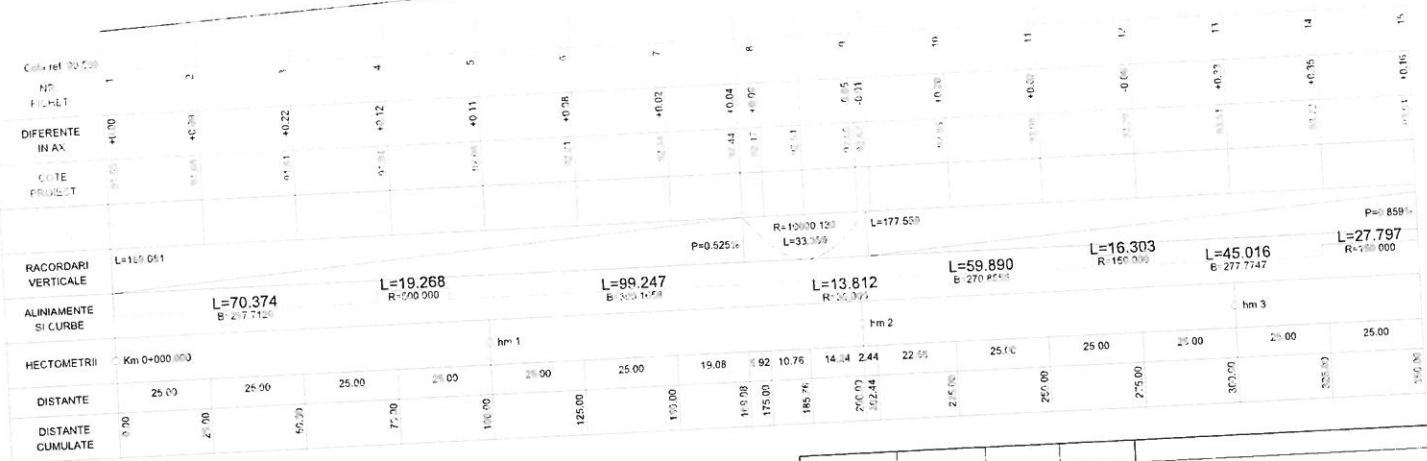

PROIECTANT GENERAL	PROIECTANT DE SPECIALITATE	SCALA	REFERINȚE PERIOADA
ING. RADOȘTE CRĂCIUN	ING. RADOȘTE CRĂCIUN	1:100	2019
ING. RADOȘTE CRĂCIUN	ING. RADOȘTE CRĂCIUN	1:100	2019
Asfaltare și modernizare drumuri de interes local în comuna Deveselu, județul Olt			S.F.
PROIECT DE CONSTRUCȚII			PL25

## PROFIL LONGITUDINAL Strada Gradinilor - sat Deveselu

Cala ref. 02.799			
NR FICHET	15	16	17
DIFERENTE IN AIR	+0.18	+0.00	+0.00
CUTII PROIECT	0.15	0.15	0.15
RACCORDARI VERTICALE L=17.50 P=0.85%			
L=27.797			
ALINIAMENT R=150.000 L=28.292			
SI CURBE B=20.5723			
HECTOMETRII			
DISTANTE	25.00	5.00	
DISTANTE CURBULATE	0	0	0

PROIECTANT GENERAL	PROIECTANT DE SPECIALITATE	SCALA	DATA	REFERINTA PERTEC/IMP/DATE	PROIECT
ING. TUDOR PETRESCU	ING. ROBERT CRISTIAN	1:100	10.07.2019	Strada Gradinilor - sat Deveselu	Asfaltare si modernizare drumuri de interes local, in comuna Deveselu, judetul Olt
ING. TUDOR PETRESCU	ING. ROBERT CRISTIAN			Strada Gradinilor - sat Deveselu	
ING. TUDOR PETRESCU	ING. ROBERT CRISTIAN			Strada Gradinilor - sat Deveselu	

# PLAN DE SITUATIE

## Strada Barajului - T1 - sat Deveselu

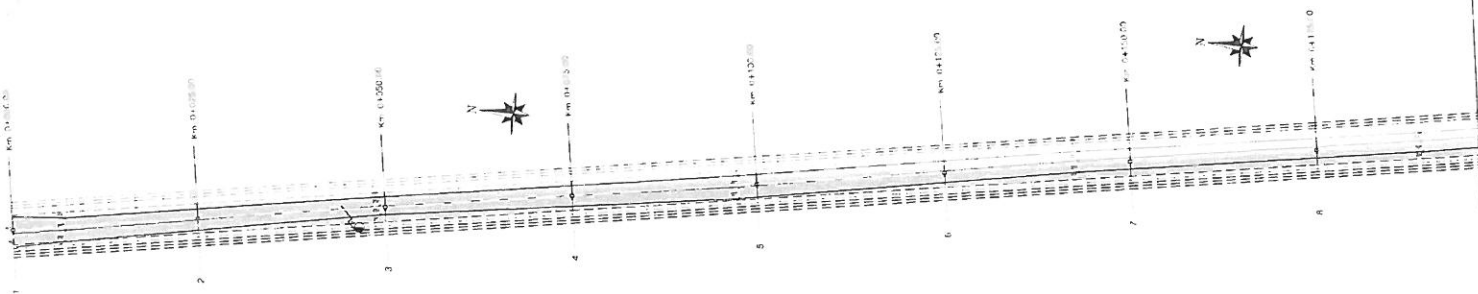

Strada Barajului

### LEGENDA - elemente proiectate

- limite carosabil proiectat
- limite trotuar proiectat
- limita sant de pământ proiectat
- limita sant de pământ proiectat
- padeți tubulari  $\phi 500$ , L=7.00m
- limita parte carosabil

### LEGENDA - elemente existente

- ex. drum
- faza ex. drum
- sant de pământ
- canal
- șanț existent

PROIECTANT GENERAL		PROIECTANT DE SPECIALITATE		REFERAT/EXPERTIZĂ AIR ZONĂ	
SC SUD OLT		S.C. SUD OLT		COMUNA DEVESELU, JUDEȚUL OLT	
PROIECTANT	PROIECTANT	PROIECTANT	PROIECTANT	PROIECTANT	PROIECTANT
Ing. Traian Petre	Ing. Radușan Cristian	Ing. Radușan Cristian	Ing. Radușan Cristian	Ing. Traian Petre	Ing. Traian Petre
				1:100	Asfaltare și modernizare drumuri de interes local, în comuna Deveselu, Județul Olt.
				10 Iulie 2018	Strada Barajului - T1 - sat Deveselu
					PS42



# PLAN DE SITUATIE

## Strada Barajului - T1 - sat Deveselu

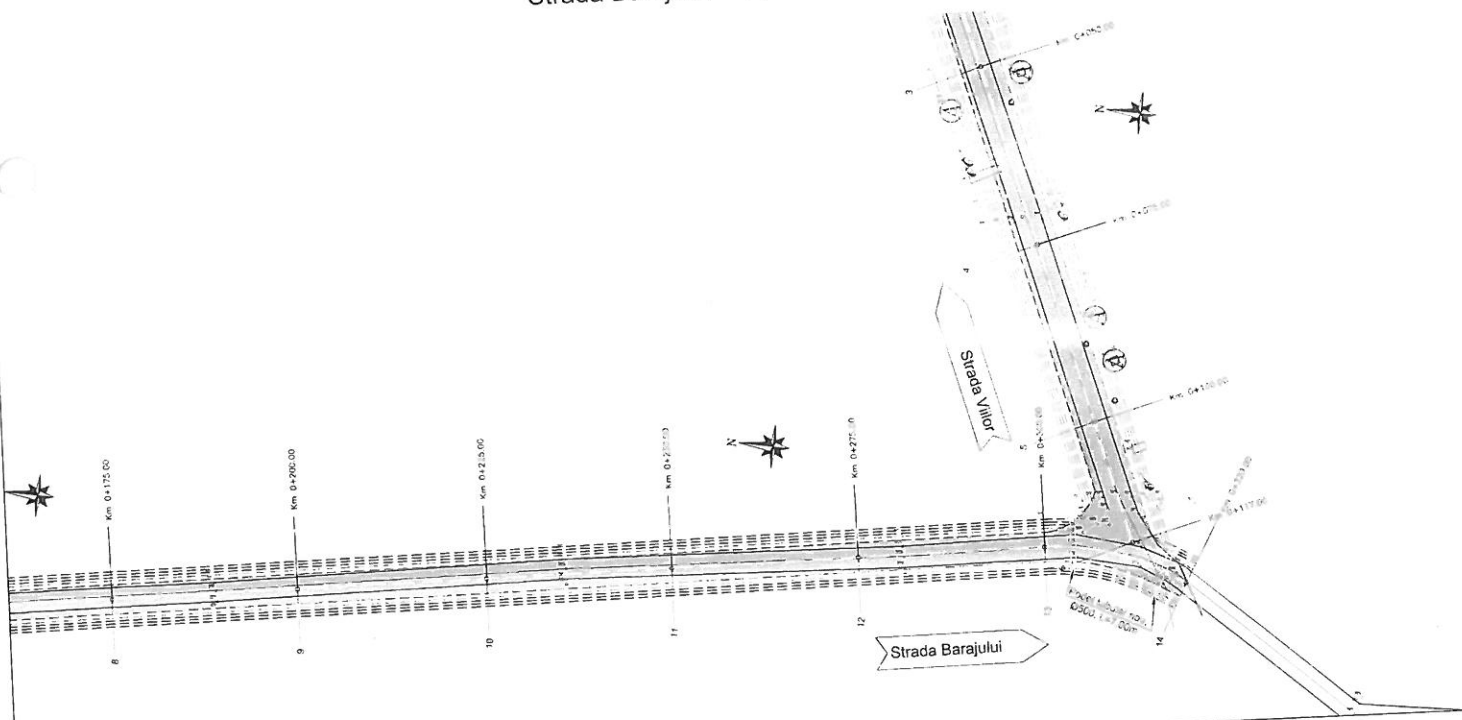

**LEGENDA - elemente proiectate**

- limita carosabil proiectat
- - - - - limita carosabilului proiectat
- limita sant de pamant proiectat
- - - - - limita sant de pamant proiectat
- ▬ pozele tuburilor #500, L=7.00m
- ▬ limita sant de pamant proiectat

**LEGENDA - elemente existente**

- ▬ Asfalt
- ▬ Margine drum
- ▬ Limita proprietate
- ▬ C.P.T. 1
- ▬ C.P.T. 2
- ▬ C.P.T. 3
- ▬ C.P.T. 4
- ▬ C.P.T. 5
- ▬ C.P.T. 6
- ▬ C.P.T. 7
- ▬ C.P.T. 8
- ▬ C.P.T. 9
- ▬ C.P.T. 10
- ▬ C.P.T. 11
- ▬ C.P.T. 12
- ▬ C.P.T. 13
- ▬ C.P.T. 14
- ▬ C.P.T. 15
- ▬ C.P.T. 16
- ▬ C.P.T. 17
- ▬ C.P.T. 18
- ▬ C.P.T. 19
- ▬ C.P.T. 20
- ▬ C.P.T. 21
- ▬ C.P.T. 22
- ▬ C.P.T. 23
- ▬ C.P.T. 24
- ▬ C.P.T. 25
- ▬ C.P.T. 26
- ▬ C.P.T. 27
- ▬ C.P.T. 28
- ▬ C.P.T. 29
- ▬ C.P.T. 30
- ▬ C.P.T. 31
- ▬ C.P.T. 32
- ▬ C.P.T. 33
- ▬ C.P.T. 34
- ▬ C.P.T. 35
- ▬ C.P.T. 36
- ▬ C.P.T. 37
- ▬ C.P.T. 38
- ▬ C.P.T. 39
- ▬ C.P.T. 40
- ▬ C.P.T. 41
- ▬ C.P.T. 42
- ▬ C.P.T. 43
- ▬ C.P.T. 44
- ▬ C.P.T. 45
- ▬ C.P.T. 46
- ▬ C.P.T. 47
- ▬ C.P.T. 48
- ▬ C.P.T. 49
- ▬ C.P.T. 50

PROIECTANT GENERAL	PROIECTANT DE SPECIALITATE	SCURT TITL	SCURT DE SPECIALITATE	REPERE/PERICOL	REPERE/PERICOL
Ing. Teodor Petric	Ing. Rodolphe Grison	1-00	1-00	Asfaltare si modernizare drumuri de interes local, in comuna Deveselu, judetul Olt	S.F.
Ing. Rodolphe Grison	Ing. Rodolphe Grison	1-00	1-00	Asfaltare si modernizare drumuri de interes local, in comuna Deveselu, judetul Olt	PS43
Ing. Rodolphe Grison	Ing. Rodolphe Grison	1-00	1-00	Asfaltare si modernizare drumuri de interes local, in comuna Deveselu, judetul Olt	PS43

# PROFIL LONGITUDINAL Strada Barajului - T1 - sat Deveselu

Km=0+142  
R=10000  
L=101.47  
p=2.05  
B=17.20  
m=1.27  
T=15.04

Km=0+211.95  
R=10000  
L=101.47  
p=2.05  
B=17.20  
m=1.27  
T=15.04

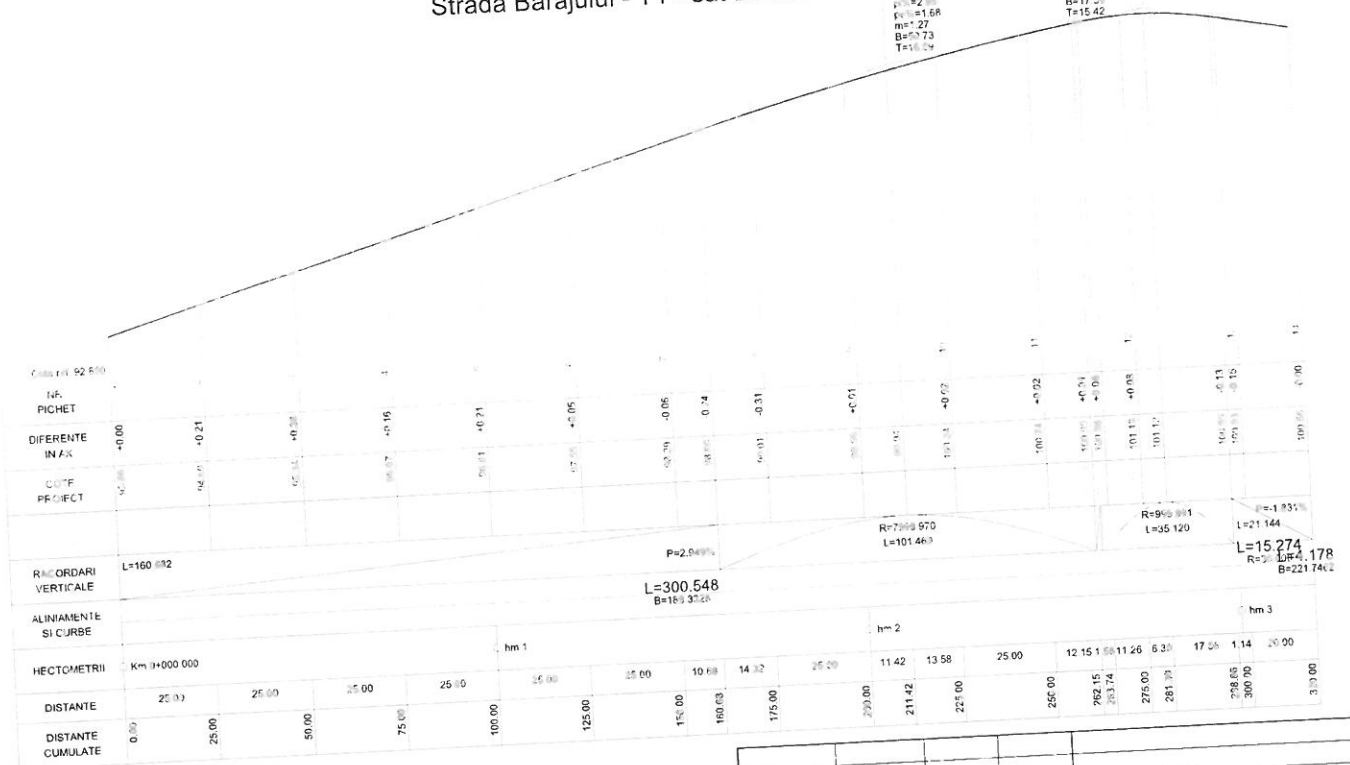

HECTOMETRII	Km 0+000 000	hm 1	hm 2	hm 3
DISTANTE	0 25 50 75 100 125 150 175 200 225 250 275 300 330	11 14 17 20 23 26 29 32 35 38 41 44 47 50	53 56 59 62 65 68 71 74 77 80 83 86 89 92 95 98 101 104 107 110 113 116 119 122 125 128 131 134 137 140 143 146 149 152 155 158 161 164 167 170 173 176 179 182 185 188 191 194 197 200 203 206 209 212 215 218 221 224 227 230 233 236 239 242 245 248 251 254 257 260 263 266 269 272 275 278 281 284 287 290 293 296 299 302 305 308 311 314 317 320 323 326 329 332	12 15 18 21 24 27 30 33 36 39 42 45 48 51 54 57 60 63 66 69 72 75 78 81 84 87 90 93 96 99 102 105 108 111 114 117 120 123 126 129 132 135 138 141 144 147 150 153 156 159 162 165 168 171 174 177 180 183 186 189 192 195 198 201 204 207 210 213 216 219 222 225 228 231 234 237 240 243 246 249 252 255 258 261 264 267 270 273 276 279 282 285 288 291 294 297 300 303 306 309 312 315 318 321 324 327 330
DISTANTE CUMULATE	0 25 50 75 100 125 150 175 200 225 250 275 300 330	11 26 41 56 71 86 101 116 131 146 161 176 191 206 221 236 251 266 281 296 311 326 341 356 371 386 401 416 431 446 461 476 491 506 521 536 551 566 581 596 611 626 641 656 671 686 701 716 731 746 761 776 791 806 821 836 851 866 881 896 911 926 941 956 971 986 1001 1016 1031 1046 1061 1076 1091 1106 1121 1136 1151 1166 1181 1196 1211 1226 1241 1256 1271 1286 1301 1316 1331 1346 1361 1376 1391 1406 1421 1436 1451 1466 1481 1496 1511 1526 1541 1556 1571 1586 1601 1616 1631 1646 1661 1676 1691 1706 1721 1736 1751 1766 1781 1796 1811 1826 1841 1856 1871 1886 1901 1916 1931 1946 1961 1976 1991 2006 2021 2036 2051 2066 2081 2096 2111 2126 2141 2156 2171 2186 2201 2216 2231 2246 2261 2276 2291 2306 2321 2336 2351 2366 2381 2396 2411 2426 2441 2456 2471 2486 2501 2516 2531 2546 2561 2576 2591 2606 2621 2636 2651 2666 2681 2696 2711 2726 2741 2756 2771 2786 2801 2816 2831 2846 2861 2876 2891 2906 2921 2936 2951 2966 2981 2996 3011 3026 3041 3056 3071 3086 3101 3116 3131 3146 3161 3176 3191 3206 3221 3236 3251 3266 3281 3296 3311 3326 3341 3356 3371 3386 3401 3416 3431 3446 3461 3476 3491 3506 3521 3536 3551 3566 3581 3596 3611 3626 3641 3656 3671 3686 3701 3716 3731 3746 3761 3776 3791 3806 3821 3836 3851 3866 3881 3896 3911 3926 3941 3956 3971 3986 4001 4016 4031 4046 4061 4076 4091 4106 4121 4136 4151 4166 4181 4196 4211 4226 4241 4256 4271 4286 4301 4316 4331 4346 4361 4376 4391 4406 4421 4436 4451 4466 4481 4496 4511 4526 4541 4556 4571 4586 4601 4616 4631 4646 4661 4676 4691 4706 4721 4736 4751 4766 4781 4796 4811 4826 4841 4856 4871 4886 4901 4916 4931 4946 4961 4976 4991 5006 5021 5036 5051 5066 5081 5096 5111 5126 5141 5156 5171 5186 5201 5216 5231 5246 5261 5276 5291 5306 5321 5336 5351 5366 5381 5396 5411 5426 5441 5456 5471 5486 5501 5516 5531 5546 5561 5576 5591 5606 5621 5636 5651 5666 5681 5696 5711 5726 5741 5756 5771 5786 5801 5816 5831 5846 5861 5876 5891 5906 5921 5936 5951 5966 5981 5996 6011 6026 6041 6056 6071 6086 6101 6116 6131 6146 6161 6176 6191 6206 6221 6236 6251 6266 6281 6296 6311 6326 6341 6356 6371 6386 6401 6416 6431 6446 6461 6476 6491 6506 6521 6536 6551 6566 6581 6596 6611 6626 6641 6656 6671 6686 6701 6716 6731 6746 6761 6776 6791 6806 6821 6836 6851 6866 6881 6896 6911 6926 6941 6956 6971 6986 7001 7016 7031 7046 7061 7076 7091 7106 7121 7136 7151 7166 7181 7196 7211 7226 7241 7256 7271 7286 7301 7316 7331 7346 7361 7376 7391 7406 7421 7436 7451 7466 7481 7496 7511 7526 7541 7556 7571 7586 7601 7616 7631 7646 7661 7676 7691 7706 7721 7736 7751 7766 7781 7796 7811 7826 7841 7856 7871 7886 7901 7916 7931 7946 7961 7976 7991 8006 8021 8036 8051 8066 8081 8096 8111 8126 8141 8156 8171 8186 8201 8216 8231 8246 8261 8276 8291 8306 8321 8336 8351 8366 8381 8396 8411 8426 8441 8456 8471 8486 8501 8516 8531 8546 8561 8576 8591 8606 8621 8636 8651 8666 8681 8696 8711 8726 8741 8756 8771 8786 8801 8816 8831 8846 8861 8876 8891 8906 8921 8936 8951 8966 8981 8996 9011 9026 9041 9056 9071 9086 9101 9116 9131 9146 9161 9176 9191 9206 9221 9236 9251 9266 9281 9296 9311 9326 9341 9356 9371 9386 9401 9416 9431 9446 9461 9476 9491 9506 9521 9536 9551 9566 9581 9596 9611 9626 9641 9656 9671 9686 9701 9716 9731 9746 9761 9776 9791 9806 9821 9836 9851 9866 9881 9896 9911 9926 9941 9956 9971 9986 10001 10016 10031 10046 10061 10076 10091 10106 10121 10136 10151 10166 10181 10196 10211 10226 10241 10256 10271 10286 10301 10316 10331 10346 10361 10376 10391 10406 10421 10436 10451 10466 10481 10496 10511 10526 10541 10556 10571 10586 10601 10616 10631 10646 10661 10676 10691 10706 10721 10736 10751 10766 10781 10796 10811 10826 10841 10856 10871 10886 10901 10916 10931 10946 10961 10976 10991 11006 11021 11036 11051 11066 11081 11096 11111 11126 11141 11156 11171 11186 11201 11216 11231 11246 11261 11276 11291 11306 11321 11336 11351 11366 11381 11396 11411 11426 11441 11456 11471 11486 11501 11516 11531 11546 11561 11576 11591 11606 11621 11636 11651 11666 11681 11696 11711 11726 11741 11756 11771 11786 11801 11816 11831 11846 11861 11876 11891 11906 11921 11936 11951 11966 11981 11996 12011 12026 12041 12056 12071 12086 12101 12116 12131 12146 12161 12176 12191 12206 12221 12236 12251 12266 12281 12296 12311 12326 12341 12356 12371 12386 12401 12416 12431 12446 12461 12476 12491 12506 12521 12536 12551 12566 12581 12596 12611 12626 12641 12656 12671 12686 12701 12716 12731 12746 12761 12776 12791 12806 12821 12836 12851 12866 12881 12896 12911 12926 12941 12956 12971 12986 13001 13016 13031 13046 13061 13076 13091 13106 13121 13136 13151 13166 13181 13196 13211 13226 13241 13256 13271 13286 13301 13316 13331 13346 13361 13376 13391 13406 13421 13436 13451 13466 13481 13496 13511 13526 13541 13556 13571 13586 13601 13616 13631 13646 13661 13676 13691 13706 13721 13736 13751 13766 13781 13796 13811 13826 13841 13856 13871 13886 13901 13916 13931 13946 13961 13976 13991 14006 14021 14036 14051 14066 14081 14096 14111 14126 14141 14156 14171 14186 14201 14216 14231 14246 14261 14276 14291 14306 14321 14336 14351 14366 14381 14396 14411 14426 14441 14456 14471 14486 14501 14516 14531 14546 14561 14576 14591 14606 14621 14636 14651 14666 14681 14696 14711 14726 14741 14756 14771 14786 14801 14816 14831 14846 14861 14876 14891 14906 14921 14936 14951 14966 14981 14996 15011 15026 15041 15056 15071 15086 15101 15116 15131 15146 15161 15176 15191 15206 15221 15236 15251 15266 15281 15296 15311 15326 15341 15356 15371 15386 15401 15416 15431 15446 15461 15476 15491 15506 15521 15536 15551 15566 15581 15596 15611 15626 15641 15656 15671 15686 15701 15716 15731 15746 15761 15776 15791 15806 15821 15836 15851 15866 15881 15896 15911 15926 15941 15956 15971 15986 16001 16016 16031 16046 16061 16076 16091 16106 16121 16136 16151 16166 16181 16196 16211 16226 16241 16256 16271 16286 16301 16316 16331 16346 16361 16376 16391 16406 16421 16436 16451 16466 16481 16496 16511 16526 16541 16556 16571 16586 16601 16616 16631 16646 16661 16676 16691 16706 16721 16736 16751 16766 16781 16796 16811 16826 16841 16856 16871 16886 16901 16916 16931 16946 16961 16976 16991 17006 17021 17036 17051 17066 17081 17096 17111 17126 17141 17156 17171 17186 17201 17216 17231 17246 17261 17276 17291 17306 17321 17336 17351 17366 17381 17396 17411 17426 17441 17456 17471 17486 17501 17516 17531 17546 17561 17576 17591 17606 17621 17636 17651 17666 17681 17696 17711 17726 17741 17756 17771 17786 17801 17816 17831 17846 17861 17876 17891 17906 17921 17936 17951 17966 17981 17996 18011 18026 18041 18056 18071 18086 18101 18116 18131 18146 18161 18176 18191 18206 18221 18236 18251 18266 18281 18296 18311 18326 18341 18356 18371 18386 18401 18416 18431 18446 18461 18476 18491 18506 18521 18536 18551 18566 18581 18596 18611 18626 18641 18656 18671 18686 18701 18716 18731 18746 18761 18776 18791 18806 18821 18836 18851 18866 18881 18896 18911 18926 18941 18956 18971 18986 19001 19016 19031 19046 19061 19076 19091 19106 19121 19136 19151 19166 19181 19196 19211 19226 19241 19256 19271 19286 19301 19316 19331 19346 19361 19376 19391 19406 19421 19436 19451 19466 19481 19496 19511 19526 19541 19556 19571 19586 19601 19616 19631 19646 19661 19676 19691 19706 19721 19736 19751 19766 19781 19796 19811 19826 19841 19856 19871 19886 19901 19916 19931 19946 19961 19976 19991 20006 20021 20036 20051 20066 20081 20096 20111 20126 20141 20156 20171 20186 20201 20216 20231 20246 20261 20276 20291 20306 20321 20336 20351 20366 20381 20396 20411 20426 20441 20456 20471 20486 20501 20516 20531 20546 20561 20576 20591 20606 20621 20636 20651 20666 20681 20696 20711 20726 20741 20756 20771 20786 20801 20816 20831 20846 20861 20876 20891 20906 20921 20936 20951 20966 20981 20996 21011 21026 21041 21056 21071 21086 21101 21116 21131 21146 21161 21176 21191 21206 21221 21236 21251 21266 21281 21296 21311 21326 21341 21356 21371 21386 21401 21416 21431 21446 21461 21476 21491 21506 21521 21536 21551 21566 21581 21596 21611 21626 21641 21656 21671 21686 21701 21716 21731 21746 21761 21776 21791 21806 21821 21836 21851 21866 21881 21896 21911 21926 21941 21956 21971 21986 22001 22016 22031 22046 22061 22076 22091 22106 22121 22136 22151 22166 22181 22196 22211 22226 22241 22256 22271 22286 22301 22316 22331 22346 22361 22376 22391 22406 22421 22436 22451 22466 22481 22496 22511 22526 22541 22556 22571 22586 22601 22616 22631 22646 22661 22676 22691 22706 22721 22736 22751 22766 22781 22796 22811 22826 22841 22856 22871 22886 22901 22916 22931 22946 22961 22976 22991 23006 23021 23036 23051 23066 23081 23096 23111 23126 23141 23156 23171 23186 23201 23216 23231 23246 23261 23276 23291 23306 23321 23336 23351 23366 23381 23396 23411 23426 23441 23456 23471 23486 23501 23516 23531 23546 23561 23576 23591 23606 23621 23636 23651 23666 23681 23696 23711 23726 23741 23756 23771 23786 23801 23816 23831 23846 23861 23876 23891 23906 23921 23936 23951 23966 23981 23996 24011 24026 24041 24056 24071 24086 24101 24116 24131 24146 24161 24176 24191 24206 24221 24236 24251 24266 24281 24296 24311 24326 24341 24356 24371 24386 24401 24416 24431 24446 24461 24476 24491 24506 24521 24536 24551 24566 24581 24596 24611 24626 24641 24656 24671 24686 24701 24716 24731 24746 24761 24776 24791 24806 24821 24836 24851 24866 24881 24896 24911 24926 24941 24956 24971 24986 25001 25016 25031 25046 25061 25076 25091 25106 25121 25136 25151 25166 25181 25196 25211 25226 25241 25256 25271 25286 25301 25316 25331 25346 25361 25376 25391 25406 25421 25436 25451 25466 25481 25496 25511 25526 25541 25556 25571 25586 25601 25616 25631 25646 25661 25676 25691 25706 25721 25736 25751 25766 25781 25796 25811 25826 25841 25856 25871 25886 25901 25916 25931 25946 25961 25976 25991 26006 26021 26036 26051 26066 26081 26096 26111 26126 26141 26156 26171 26186 26201 26216 26231 26246 26261 26276 26291 26306 26321 26336 26351 26366 26381 26396 26411 26426 26441 26456 26471 26486 26501 26516 26531 26546 26561 26576 26591 26606 26621 2663		

# PLAN DE SITUATIE

## Strada Barajului - T2 - sat Deveselu

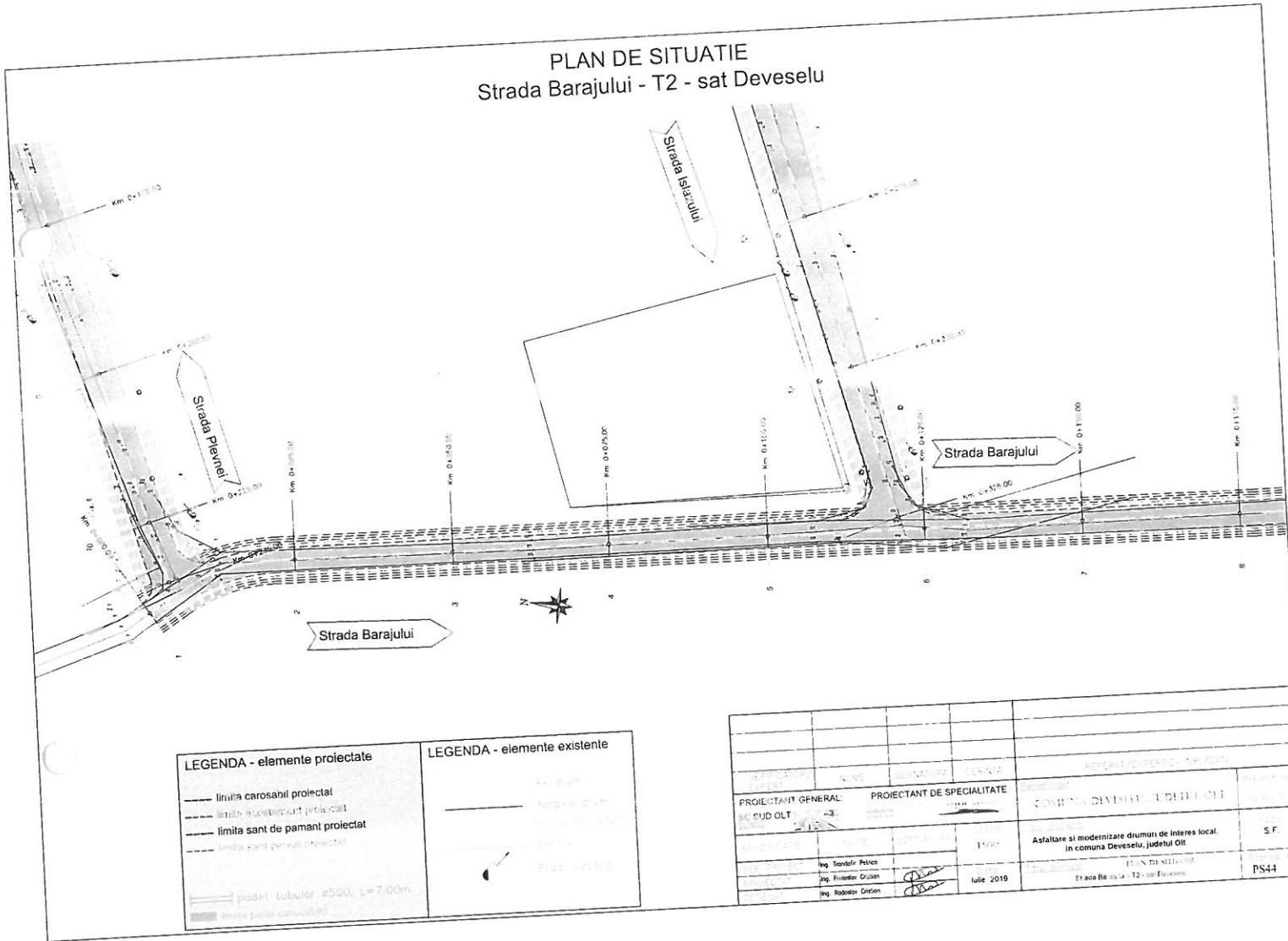

**LEGENDA - elemente proiectate**

- linia carosabil proiectat
- linia de amenajare proiectat
- limita sant de pamant proiectat
- limita sant perimetru proiectat
- podet tubular #500, L=7.00m
- limita teren catavala

**LEGENDA - elemente existente**

- teren
- linie de drum
- linie de utilitate
- canal
- fosa

PROIECTANT GENERAL		PROIECTANT DE SPECIALITATE		REPERUT / EXPERTIZ - TRAZAS	
S.C. SUD OLT		S.C. SUD OLT		COMUNA DEVESELU, JUDEUL OLT	
SCHEMATE		SCHEMATE		Asfaltare si modernizare drumuri de interes local in comuna Deveselu, judetul Olt	
Ing. Sandor Petric		Ing. Sandor Petric		1:500	
Ing. Florin Crisan		Ing. Florin Crisan		Iulie 2019	
Ing. Rodolof Crisan		Ing. Rodolof Crisan		Strada Barajului - T2 - sat Deveselu	
				S.F.	
				PS44	

# PLAN DE SITUATIE Strada Barajului - T2 - sat Deveselu

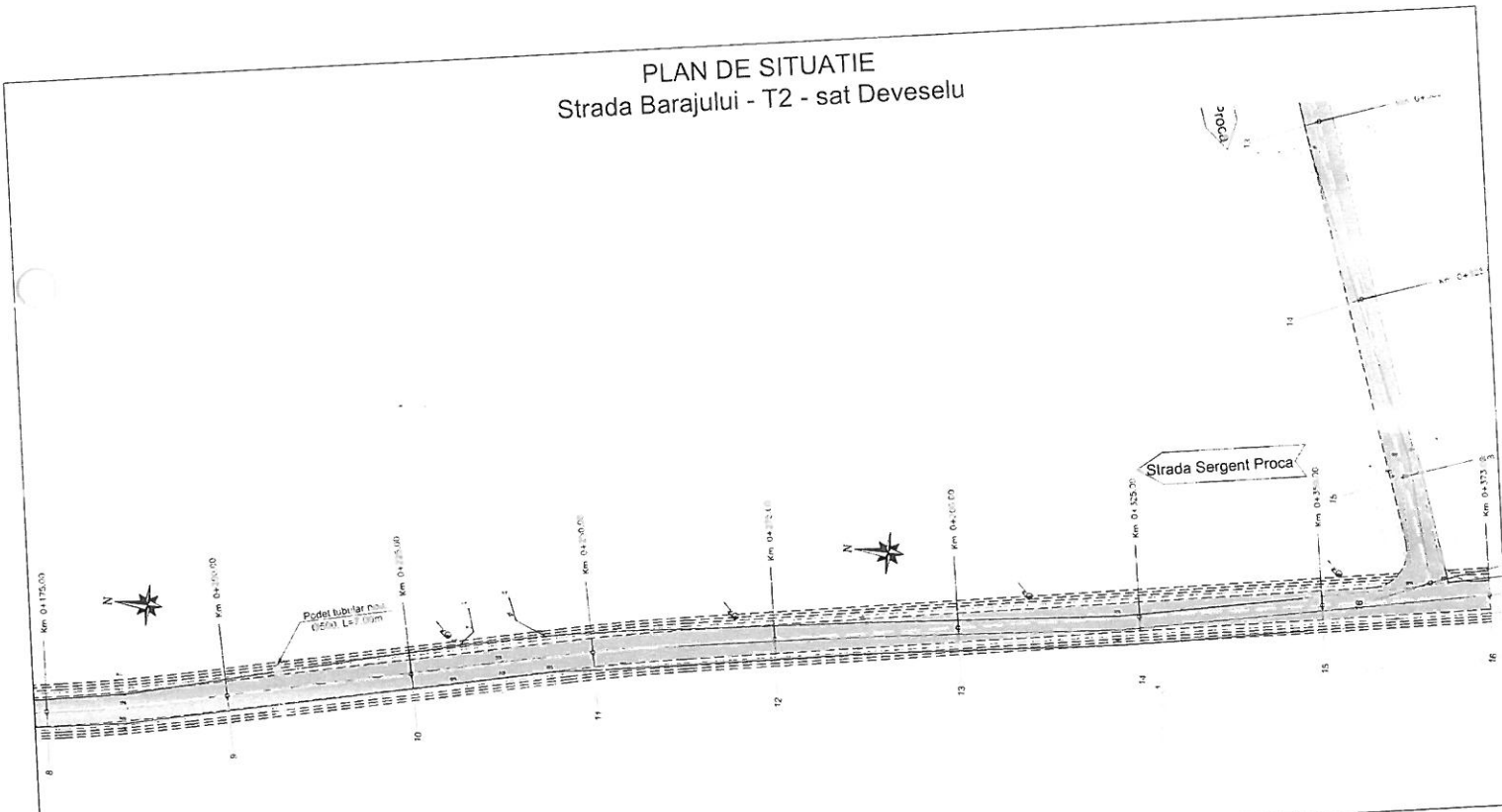

**LEGENDA - elemente proiectate**

- limita carosabil proiectat
- - - limita vegetațional proiectat
- limita sani de pamant proiectat
- - - limita sani de pamant proiectat
- podul tubular #500, L=7,00m

**LEGENDA - elemente existente**

- Margine 20cm
- Cămin
- Stop exist

PROIECTANT GENERAL	PROIECTANT DE SPECIALITATE	SC SUD-ULT	COMUNA DEVESELU, JUDEȚUL OLT
Ing. Todorici Petre	Ing. Radușor Crăciun	Ing. Radușor Crăciun	Asfaltare și modernizare drumuri de interes local, în comuna Deveselu, județul Olt.
Ing. Radușor Crăciun	Ing. Radușor Crăciun	Ing. Radușor Crăciun	PLAN DE SITUATIE
		Julie 2019	Strada Barajului - T2 - sat Deveselu
			PS45



# PLAN DE SITUATIE Strada Viilor - sat Deveselu

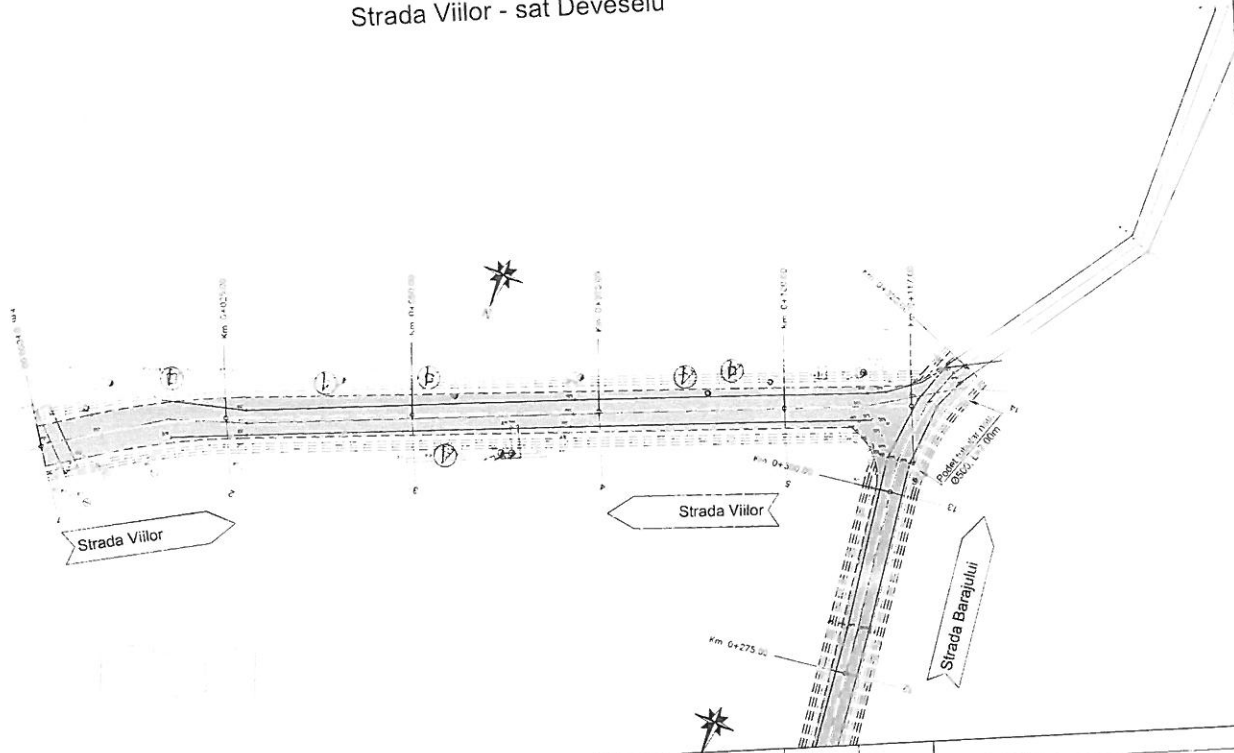

### LEGENDA - elemente proiectate

- limita carosabil proiectat
- - - limita acostament proiectat
- - - limita sant de pamant proiectat
- - - limita sari de pamant proiectat
- podet tubular #500, L=7.00m
- limita calei carosabile

### LEGENDA - elemente existente

- Av. drum
- Margine drum
- Linie de Proiectare
- Canal
- Straz. nr. 10/11

PROIECTANT GENERAL SEC. U.D. ILT		PROIECTANT DE SPECIALITATE		REPERATZEI PERTEC. INLOCURII	
ASPECT		SCALA		DATA	
SPECIFICATIE		NOTA		DATA	
Ing. Traian Petre		Ing. Radu Cristian		Iulie 2019	
Ing. Radu Cristian		Ing. Radu Cristian		Iulie 2019	
Ing. Radu Cristian		Ing. Radu Cristian		Iulie 2019	
Asfaltare si modernizare drumuri de interes local. in comuna Deveselu, judetul Olt				S.F.	
Deveselu - sat Deveselu				PS46	

## PROFIL LONGITUDINAL Strada Viilor - sat Deveselu

$K=0.0115$   
 $R=1000$   
 $L=31.31$   
 $p_1=2.96$   
 $p_2=-1.59$   
 $m=0.4$   
 $B=12.5$   
 $T=11.62$

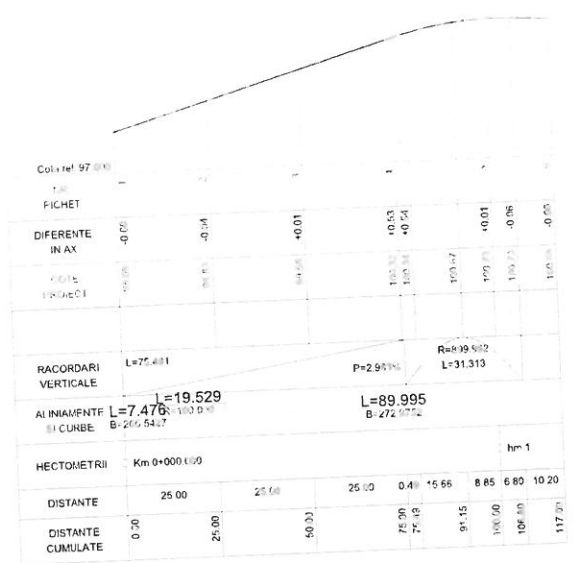

PROIECTANT GENERAL	PROIECTANT DE SPECIALITATE	SCALA	PROIECT	PROIECT DE SPECIALITATE
Ing. Traian Petre	Ing. Radu Ciomara	1:100	100	Asfaltare si modernizare drumuri de interes local, in comuna Deveselu, judetul Olt
Ing. Radu Ciomara	Ing. Radu Ciomara	100	100	Asfaltare si modernizare drumuri de interes local, in comuna Deveselu, judetul Olt
Ing. Radu Ciomara	Ing. Radu Ciomara	100	100	Asfaltare si modernizare drumuri de interes local, in comuna Deveselu, judetul Olt







# PROFIL LONGITUDINAL

## Strada Plevnei - sat Deveselu

Km=0+16.65  
 R=500.00  
 L=14.72  
 P=3.36  
 F=4.41  
 m=2.54  
 B=7.00  
 T=5.41

NR PICHET	1	2	3	4	5	6	7	8	9	10	11
DIFERENTE IN AX	+0.00	+0.03	+0.10	+0.14	+0.12	-0.05	-0.18	-0.14	-0.37	+0.10	-0.05
COTE PROIECT	10.50	10.11	9.91	9.77	9.65	9.50	9.32	9.18	8.81	8.71	8.66
RACORDURI VERTICALE	L=209.296										P=3.34%
ALINIAMENTE SI CURBE	L=235.000 B=272.114										hm 2
HECTOMETRI	Km 0+000.000										hm 1
DISTANTE	25.00	25.00	25.00	25.00	25.00	25.00	25.00	25.00	25.00	9.30	7.36
DISTANTE CUMULATE	0.00	25.00	50.00	75.00	100.00	125.00	150.00	175.00	200.00	209.30	216.66
										224.01	231.37
										240.67	248.03
										247.33	254.69
										254.69	262.05
										262.05	269.41
										269.41	276.77
										276.77	284.13
										284.13	291.49
										291.49	298.85
										298.85	306.21
										306.21	313.57
										313.57	320.93
										320.93	328.29
										328.29	335.65
										335.65	343.01
										343.01	350.37
										350.37	357.73
										357.73	365.09
										365.09	372.45
										372.45	379.81
										379.81	387.17
										387.17	394.53
										394.53	401.89
										401.89	409.25
										409.25	416.61
										416.61	423.97
										423.97	431.33
										431.33	438.69
										438.69	446.05
										446.05	453.41
										453.41	460.77
										460.77	468.13
										468.13	475.49
										475.49	482.85
										482.85	490.21
										490.21	497.57
										497.57	504.93
										504.93	512.29
										512.29	519.65
										519.65	527.01
										527.01	534.37
										534.37	541.73
										541.73	549.09
										549.09	556.45
										556.45	563.81
										563.81	571.17
										571.17	578.53
										578.53	585.89
										585.89	593.25
										593.25	600.61
										600.61	607.97
										607.97	615.33
										615.33	622.69
										622.69	630.05
										630.05	637.41
										637.41	644.77
										644.77	652.13
										652.13	659.49
										659.49	666.85
										666.85	674.21
										674.21	681.57
										681.57	688.93
										688.93	696.29
										696.29	703.65
										703.65	711.01
										711.01	718.37
										718.37	725.73
										725.73	733.09
										733.09	740.45
										740.45	747.81
										747.81	755.17
										755.17	762.53
										762.53	769.89
										769.89	777.25
										777.25	784.61
										784.61	791.97
										791.97	799.33
										799.33	806.69
										806.69	814.05
										814.05	821.41
										821.41	828.77
										828.77	836.13
										836.13	843.49
										843.49	850.85
										850.85	858.21
										858.21	865.57
										865.57	872.93
										872.93	880.29
										880.29	887.65
										887.65	895.01
										895.01	902.37
										902.37	909.73
										909.73	917.09
										917.09	924.45
										924.45	931.81
										931.81	939.17
										939.17	946.53
										946.53	953.89
										953.89	961.25
										961.25	968.61
										968.61	975.97
										975.97	983.33
										983.33	990.69
										990.69	998.05
										998.05	1005.41
										1005.41	1012.77
										1012.77	1020.13
										1020.13	1027.49
										1027.49	1034.85
										1034.85	1042.21
										1042.21	1049.57
										1049.57	1056.93
										1056.93	1064.29
										1064.29	1071.65
										1071.65	1079.01
										1079.01	1086.37
										1086.37	1093.73
										1093.73	1101.09
										1101.09	1108.45
										1108.45	1115.81
										1115.81	1123.17
										1123.17	1130.53
										1130.53	1137.89
										1137.89	1145.25
										1145.25	1152.61
										1152.61	1160.00

PROIECTANT GENERAL	PROIECTANT DE SPECIALITATE			
Ing. Vasile Petric	Ing. Robert Cimariu	1100		
Ing. Robert Cimariu	Ing. Robert Cimariu	1100		
Ing. Robert Cimariu				
Comuna Deveselu, Judetul Olt		Astaltare si modernizare drumului de interes local, in comuna Deveselu, Judetul Olt		S.F.
Strada Plevnei, sat Deveselu		Strada Plevnei, sat Deveselu		PL30

## PLAN DE SITUATIE Strada Islazului - sat Deveselu

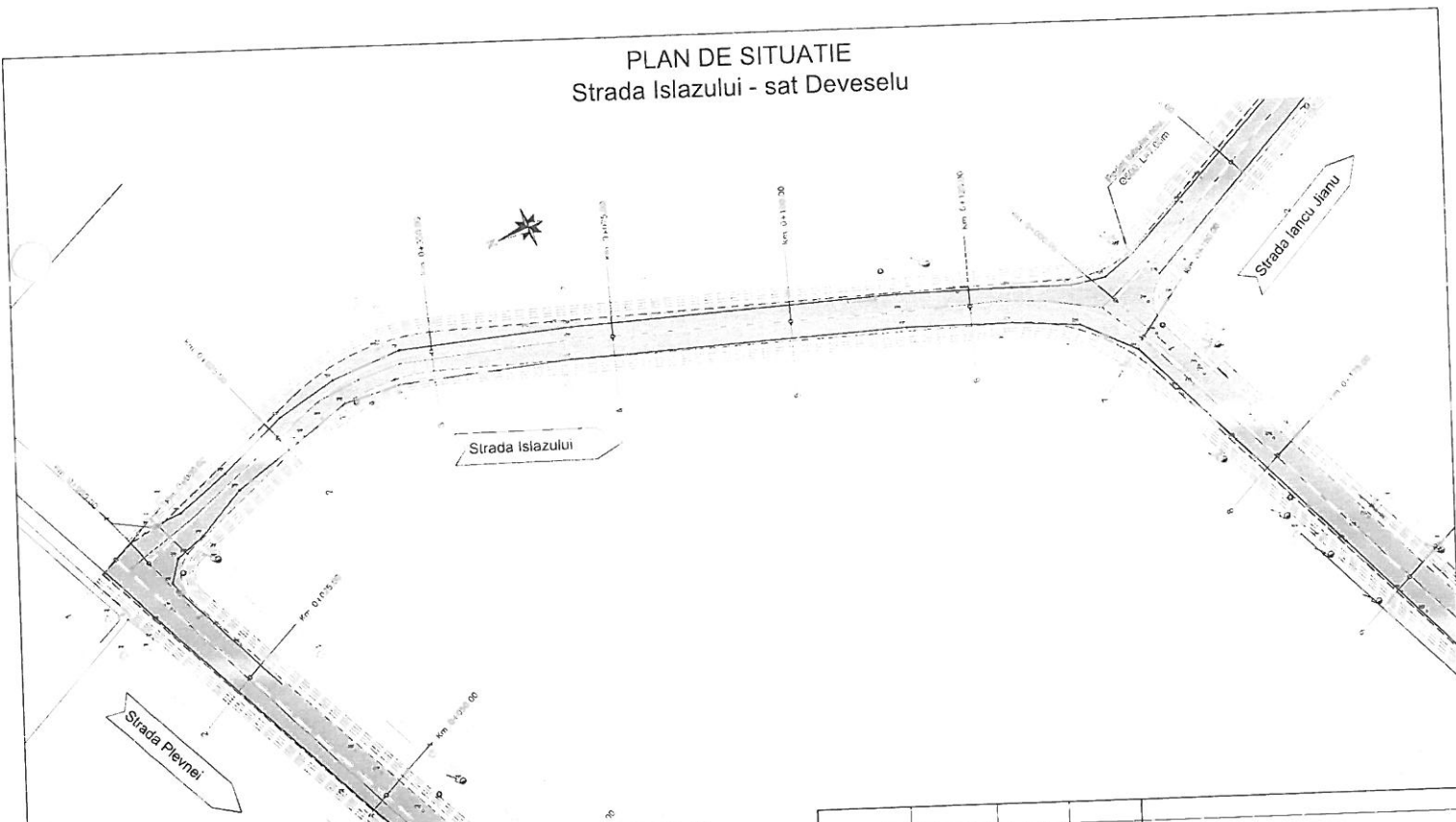

**LEGENDA - elemente proiectate**

- limita carosabil proiectat
- limita acostament proiectat
- limita sant de pamant proiectat
- limita sant de pamant existent
- podul tubular #500, L=7.00m
- limita parte carosabil

**LEGENDA - elemente existente**

- ax drum
- margine drum
- ingheala
- stop noaptea

PROIECTANT GENERAL	PROIECTANT DE SPECIALITATE	SCALA	DATA	PROIECT
ING. SUD OLT	ING. TRANDAFIR PETROS ING. RADOLAV CRISTIAN ING. RADOLAV CRISTIAN	1:400	Iulie 2019	Asfaltare si modernizare drumuri de interes local, in comuna Deveselu, judetul Olt
				PS-49

# PLAN DE SITUATIE Strada Islazului - sat Deveselu

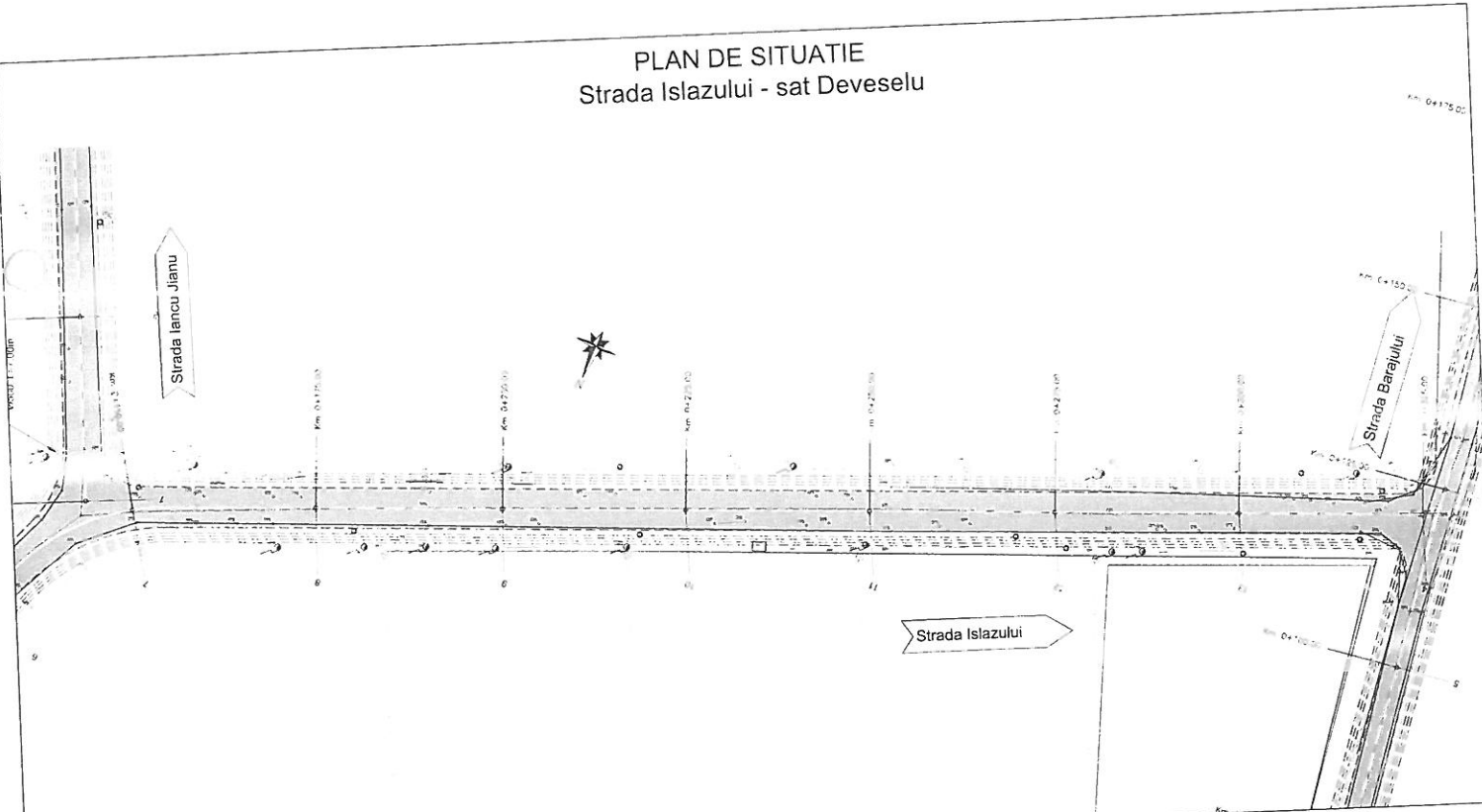

**LEGENDA - elemente proiectate**

- limita carosabil proiectat
- limita acostament proiectat
- limita sant de pamant proiectat
- limita sant perete proiectat
- podet tubular  $\phi 500$ , L=7.00m
- limita panta carosabil

**LEGENDA - elemente existente**

- M. drum
- Marghe drum
- Limita
- M. p. exist.

PROIECTANT GENERAL	PROIECTANT DE SPECIALITATE	SCALA	DATA	STADIUL DE EXECUTIE	STADIUL DE PROIECTARE
SCAD OLT		1:500	July 2019		
Ing. Stancu Petric	Ing. Bobotea Gheorghe				
Ing. Bobotea Gheorghe	Ing. Bobotea Gheorghe				
Ing. Bobotea Gheorghe	Ing. Bobotea Gheorghe				

PROIECTANT GENERAL	PROIECTANT DE SPECIALITATE	SCALA	DATA	STADIUL DE EXECUTIE	STADIUL DE PROIECTARE
SCAD OLT		1:500	July 2019		
Ing. Stancu Petric	Ing. Bobotea Gheorghe				
Ing. Bobotea Gheorghe	Ing. Bobotea Gheorghe				
Ing. Bobotea Gheorghe	Ing. Bobotea Gheorghe				

PROIECTANT GENERAL	PROIECTANT DE SPECIALITATE	SCALA	DATA	STADIUL DE EXECUTIE	STADIUL DE PROIECTARE
SCAD OLT		1:500	July 2019		
Ing. Stancu Petric	Ing. Bobotea Gheorghe				
Ing. Bobotea Gheorghe	Ing. Bobotea Gheorghe				
Ing. Bobotea Gheorghe	Ing. Bobotea Gheorghe				



## PLAN DE SITUATIE Strada Iancu Jianu - sat Deveselu

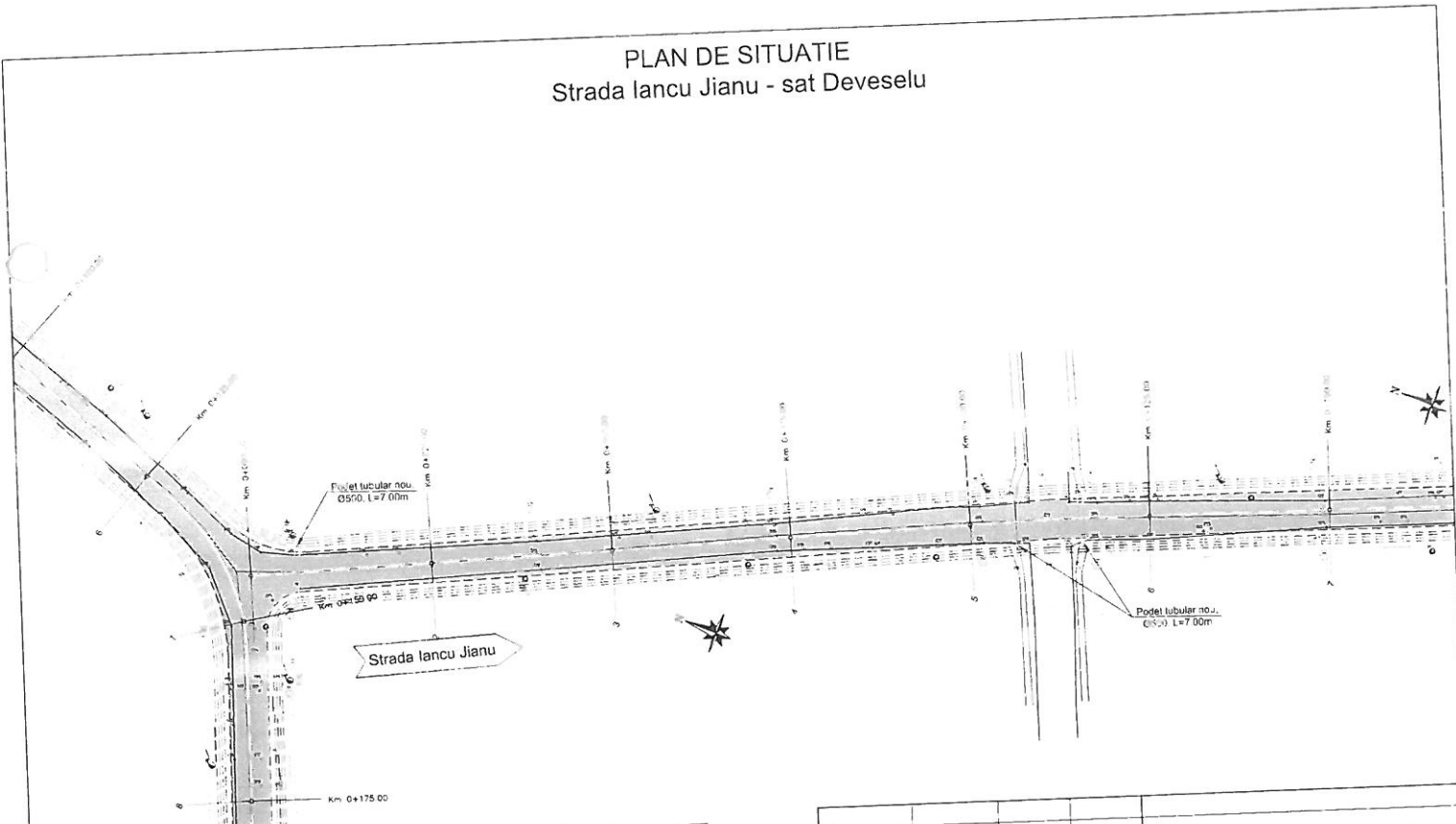

**LEGENDA - elemente proiectate**

- limita carosabil proiectat
- linia acostament proiectat
- limita sant de pamant proiectat
- linia sant de pamant proiectat
- ▬ podet tubular Ø500, L=7.00m
- ▬ linia potec canalizata

**LEGENDA - elemente existente**

- ▬ Margine drum
- ▬ Cămin
- ▬ Cămin vechi

PROIECTANT GENERAL SCMD OLT	PROIECTANT DE SPECIALITATE SCMD OLT	COMUNA DIVISIONALĂ DE ÎNȚĂLĂȘ	S.F.
PROIECTANT Ing. Tănăsescu Petrică	PROIECTANT Ing. Răduțescu Cristian	Asfaltare și modernizare drumuri de interes local, în comuna Deveselu, județul Olt	PLAN DE SITUATIE
Ing. Răduțescu Cristian	Ing. Răduțescu Cristian	Iulie 2019	PSS1

# PLAN DE SITUATIE

## Strada Iancu Jianu - sat Deveselu

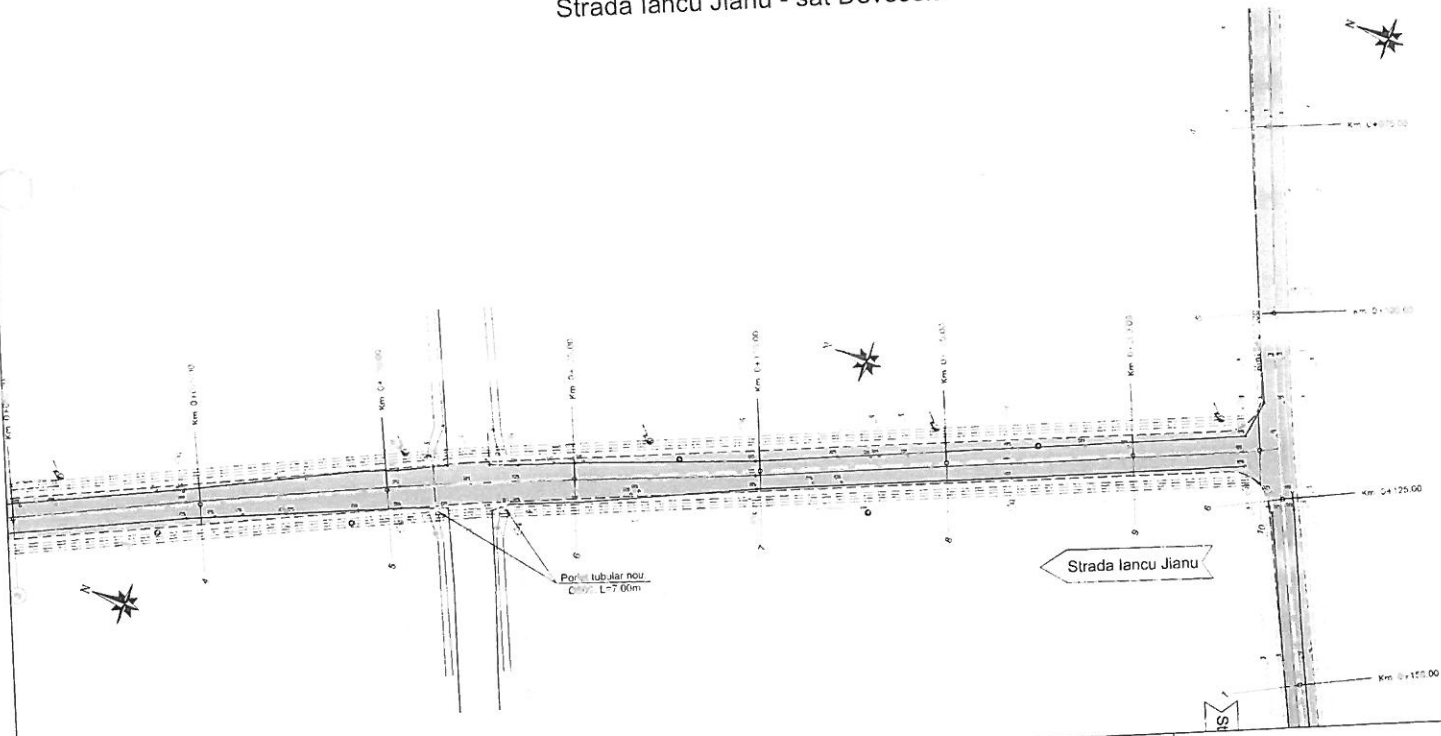

### LEGENDA - elemente proiectate

- limita carosabil proiectat
- limita acostament proiectat
- limita sant de pamant proiectat
- podet tubular: e=500, L=7.00m

### LEGENDA - elemente existente

- linie drum
- linie drum
- linie drum
- linie drum

PROIECTANT GENERAL		PROIECTANT DE SPECIALITATE		COMANDA DIVIZIEI DE PROIECTARE	
S.C. SUD OLT		[Signature]		COMANDA DIVIZIEI DE PROIECTARE	
PROIECTANT	ING. TRANDAFIR PETRUS	PROIECTANT	ING. RADOIU CRISTIAN	PROIECTANT	ING. RADOIU CRISTIAN
PROIECTANT	ING. RADOIU CRISTIAN	PROIECTANT	[Signature]	PROIECTANT	[Signature]
PROIECTANT	ING. RADOIU CRISTIAN	PROIECTANT	[Signature]	PROIECTANT	[Signature]
Asfaltare si modernizare drumuri de interes local in comuna Deveselu, Judetul Olt				S.F.	
Strada Iancu Jianu - sat Deveselu				PS52	





# PLAN DE SITUATIE

## Strada Sergent Proca - sat Deveselu

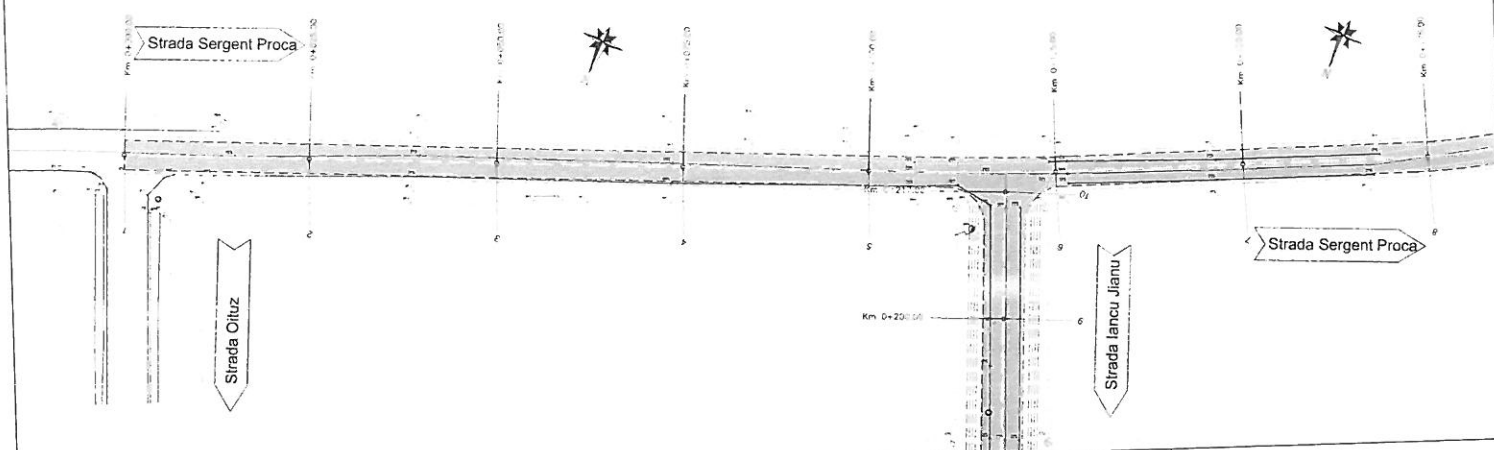

LEGENDA - elemente proiectate	LEGENDA - elemente existente
<ul style="list-style-type: none"> <li>--- limita carosabil proiectat</li> <li>--- limita acciunilor proiectat</li> <li>--- limita sant de pamant proiectat</li> <li>--- limita canal proiectat</li> </ul>	<ul style="list-style-type: none"> <li>— drum</li> <li>— margine drum</li> <li>— limita proprietate</li> <li>— canal</li> <li>— sant</li> </ul>
<ul style="list-style-type: none"> <li>— podet tubular #500, L=7.00m</li> </ul>	

PROIECTANT GENERAL		PROIECTANT DE SPECIALITATE		REPERAT/REPERTUL PROIECT	
SC SUD OLT				COMUNA DE VINEI, JUDETEL OLT	
				Astaltare si modernizare drumuri de interes local, in comuna Deveselu, judetul Olt	Plan de situatie
				PLAN DE SITUATIE	Plan de situatie
				Strada Sergent Proca - sat Deveselu	PS53

## PLAN DE SITUATIE Strada Sergent Proca - sat Deveselu

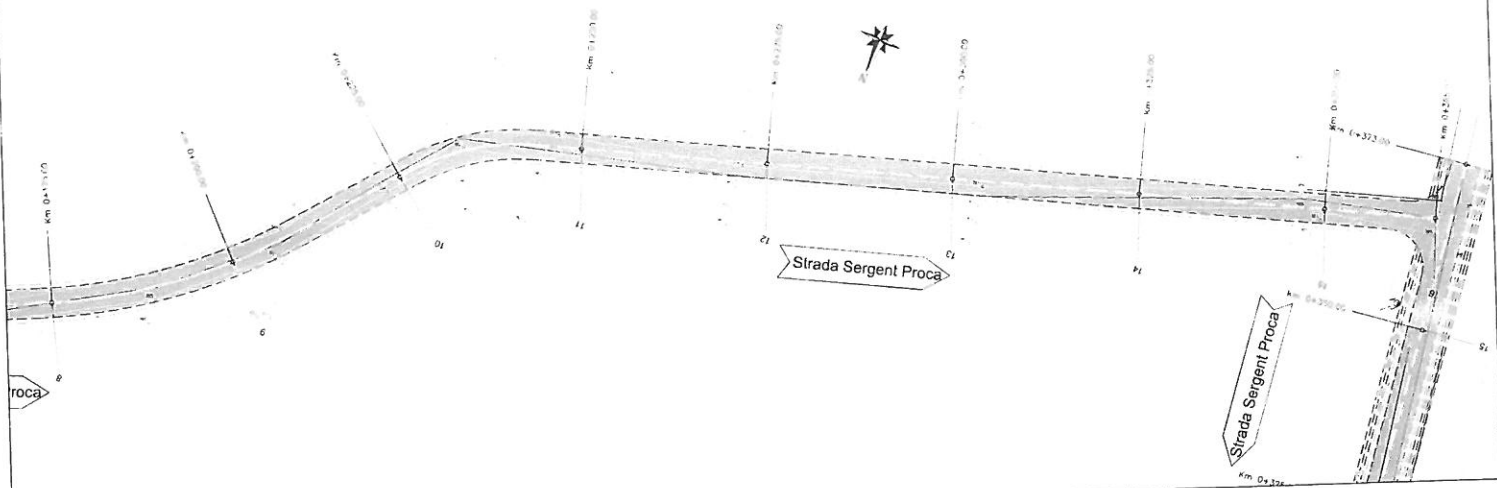

LEGENDA - elemente proiectate	LEGENDA - elemente existente
<ul style="list-style-type: none"> <li>----- linia carosabil proiectat</li> <li>----- linia sustinuta proiectat</li> <li>----- limita sant de pamant proiectat</li> <li>----- linia sant de sant proiectat</li> <li>----- podet tubular #500, L=7.00m</li> <li>----- linia utilitatilor</li> </ul>	<ul style="list-style-type: none"> <li>— drum</li> <li>— linie drum</li> <li>— linie utilitatilor</li> <li>— sant</li> <li>— linie electrice</li> </ul>

CATEGORIA	NOME	SEMNATUR	CERINTA	REFERAT/PERMIS/ANEXA
PROIECTANT GENERAL	SC SUD OLT			PROIECTANT DE SPECIALITATE
PROIECTANT DE SPECIALITATE				COMUNA DE VESELU, JUDEUL OLT
PROIECTANT DE SPECIALITATE				Asfaltare si modernizare drumuri de interes local, in comuna Deveselu, judetul Olt
PROIECTANT DE SPECIALITATE	Ing. Terezie Petrice		1500	12.08.2019
PROIECTANT DE SPECIALITATE	Ing. Robert Cristian		1500	12.08.2019
PROIECTANT DE SPECIALITATE	Ing. Robert Cristian		1500	12.08.2019
PROIECTANT DE SPECIALITATE				Strada Sergent Proca - sat Deveselu
PROIECTANT DE SPECIALITATE				PS54

# PROFIL LONGITUDINAL

## Strada Sergent Proca - sat Deveselu

Km=0+210.44  
 R=1820.00  
 L=101.10  
 p=1.30  
 pe=0.35  
 m=0.86  
 B=14.92  
 T=3.15

Km=0+182.79  
 R=4190.00  
 L=101.10  
 p=1.73  
 pe=1.20  
 m=2.53  
 B=22.06  
 T=2.46

NO PICHET	1	2	3	4	5	6	7	8	9	10	11	12	13	14	15						
DIFERENTE IN AX																					
DATE PROIECT	15.79	10.71	13.10	10.15	10.05	10.03	10.17	10.02	10.27	10.37	10.31	10.02	10.71	10.79	10.87						
RACORDARI VERTICALE	L=32.238	P=3.727%		R=3699.915 L=101.062		L=62.194		P=1.113%	R=3450.190 L=29.533	L=120.519					P=0.347%						
ALINIMENTE SI CURBE			L=108.911 B=274.2512		L=18.696 R=300.000	L=45.484 B=270.2917		L=36.150 R=60.000	L=17.486 B=241.1147	L=17.224 R=30.000			L=121.049 B=278.0799								
HECTOMETRII	Km 0+000.000																				
DISTANTE	25.00	7.24	17.76	25.00	7.79	17.11	25.00	8.33	18.67	25.00	20.53	4.47	15.44	14.56	0.36	24.64	25.00	25.00	25.00	25.00	4.10
DISTANTE CUMULATE	0.00	25.00	32.24	50.00	57.79	74.90	100.00	108.33	127.00	152.67	178.00	182.47	197.91	213.35	227.91	242.55	267.19	292.19	317.19	342.19	387.19

PROIECTANT GENERAL	PROIECTANT DE SPECIALITATE	SCURT DLT	COMUNA DEVENELU, JUDEUL OLT	SCURT DLT	COMUNA DEVENELU, JUDEUL OLT
Ing. Andrei Petica	Ing. Radu Dan	2019	2019	2019	2019
Ing. Radu Dan	Ing. Radu Dan	2019	2019	2019	2019
Asfaltare si modernizare drumuri de interes local, in comuna Deveselu, judetul Olt			Asfaltare si modernizare drumuri de interes local, in comuna Deveselu, judetul Olt		
Iulie 2019			Iulie 2019		
S.F.			S.F.		
PL33			PL33		

## PROFIL LONGITUDINAL Strada Sergent Proca - sat Deveselu

Km=0-14.10  
 R=100.00  
 L=14.10  
 p=0.05  
 i=0.001  
 m=0.2  
 B=2.0  
 Te=0.85

Cota ref. 101.809	
NR. PIVOT	16
DIFFERENȚE IN AX	0.00
COTE PROIECT	104.809 104.809 104.809
FAZORDARI VERTICALE	
ALINIAMENTE SI CURBE	L=121.049 B=276.0759
HECTOMETRII	
DISTANȚE	7.20 3.10 4.10
DISTANȚE CUMULATE	0.00 3.10 7.20 11.30

PROIECTANT GENERAL	PROIECTANT DE SPECIALITATE	SCARA	DATA	PROIECT	PROIECTANT
SC SUD OLT				COMUNA DIVESLU, JUDEȚUL OLT	
		1:100		Asfaltare și modernizare drumuri de interes local, în comuna Deveselu, județul Olt	S.F.
	Ing. Teodor Petrică				
	Ing. Rodolof Cristian				
	Ing. Rodolof Cristian		Iulie 2019	Strada Sergent Proca - sat Deveselu	PL34

## PLAN DE SITUATIE Strada Cantonului - sat Deveselu

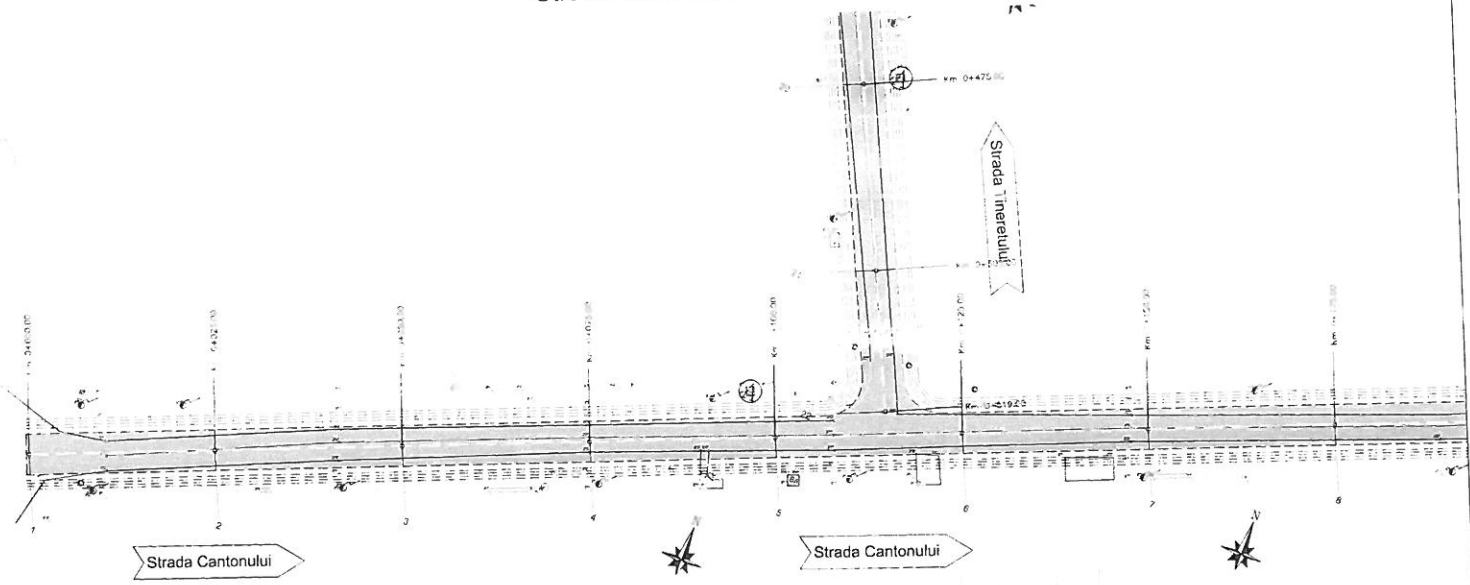

**LEGENDA - elemente proiectate**

- limita carosabil proiectat
- limita acostament proiectat
- limita sant de pamant proiectat
- limita gard de fier proiectat
- podet tubular #500, L=7.00m
- limita gard de fier proiectat

**LEGENDA - elemente existente**

- ax drum
- margine drum
- bordura trotuar
- gard
- stop tehnic

PROIECTANT GENERAL	PROIECTANT DE SPECIALITATE	SCARA	INTERAT (D. PERTIC./MP./DATA)
CC SUD OLT		1:500	COMUNA, DIVIZIUNEA JUDETLUI OLT
ASFALTARE SI MODERNIZARE DRUMURI DE INTERES LOCAL in comuna Deveselu, judetul Olt			S.F.
Ing. Stancu Petricu		1500	STRADA CANTONULUI, SAT DEVESELU
Ing. Radulescu Cristian		1500	STRADA CANTONULUI, SAT DEVESELU
Ing. Radulescu Cristian		1500	STRADA CANTONULUI, SAT DEVESELU
			PS55





## PLAN DE SITUATIE

### Drum satesc Ds1395 - 1 - sat Deveselu

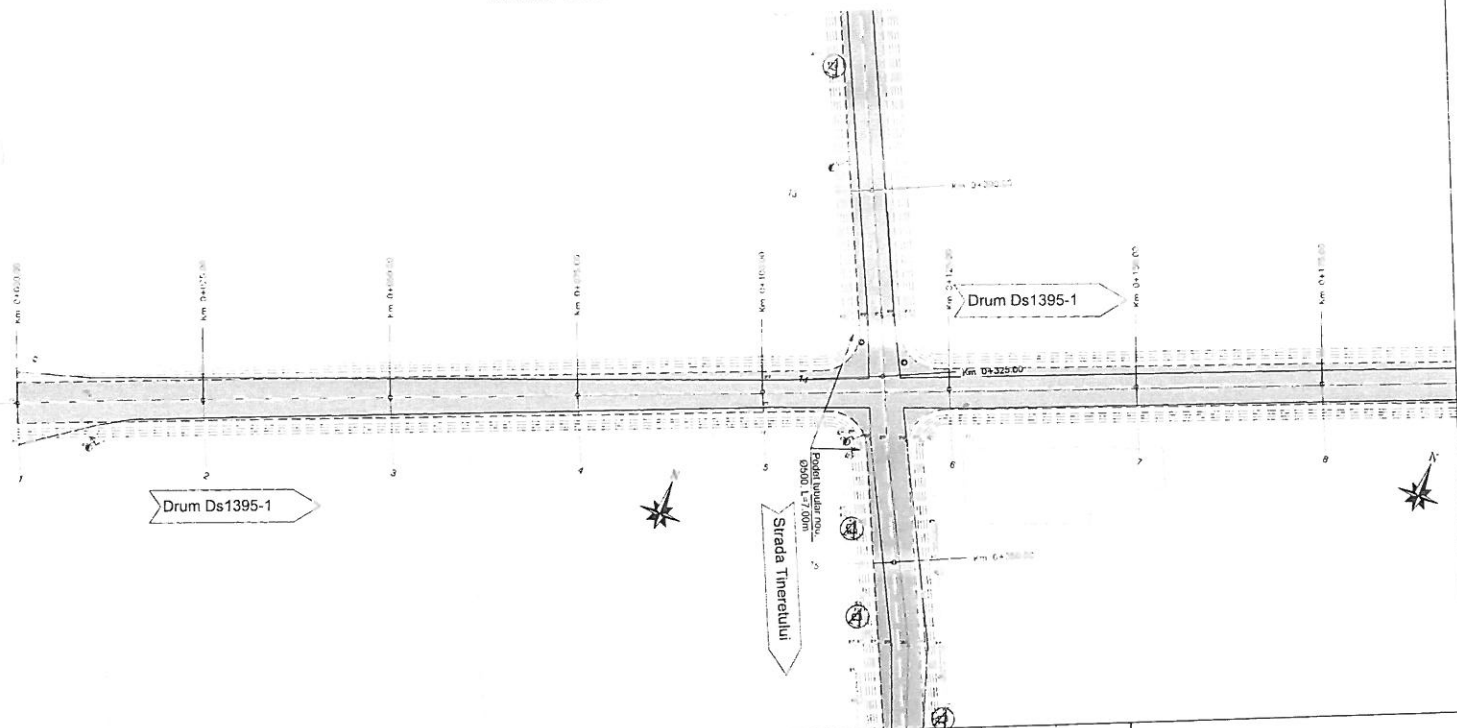

#### LEGENDA - elemente proiectate

- limita carosabil proiectat
- limita existentă proiectat
- limita sant de pamant proiectat
- limita sant de pamant existent
- podet tubular #500, L=7.00m

#### LEGENDA - elemente existente

- drum
- margini drum
- santuri
- podet tubular

PROIECTANT GENERAL	PROIECTANT DE SPECIALITATE	PROIECTANT	PROIECTANT
SC MUD OLT			
PROIECT DE SPECIALITATE Asfaltare si modernizare drumuri de interes local, in comuna Deveselu, judetul Olt		1:100	S.F.
Ing. Todorici Petric			
Ing. Radovan Gheorghe		10.06.2019	PSS7
Ing. Radovan Gheorghe			





## PROFIL LONGITUDINAL Drum satesc Ds1395 - 1 - sat Deveselu

Km=0+000.42  
R=800.00  
L=161.254  
p=+2.00  
p0=+0.01  
m=2.00  
R=41.10  
T=41.10

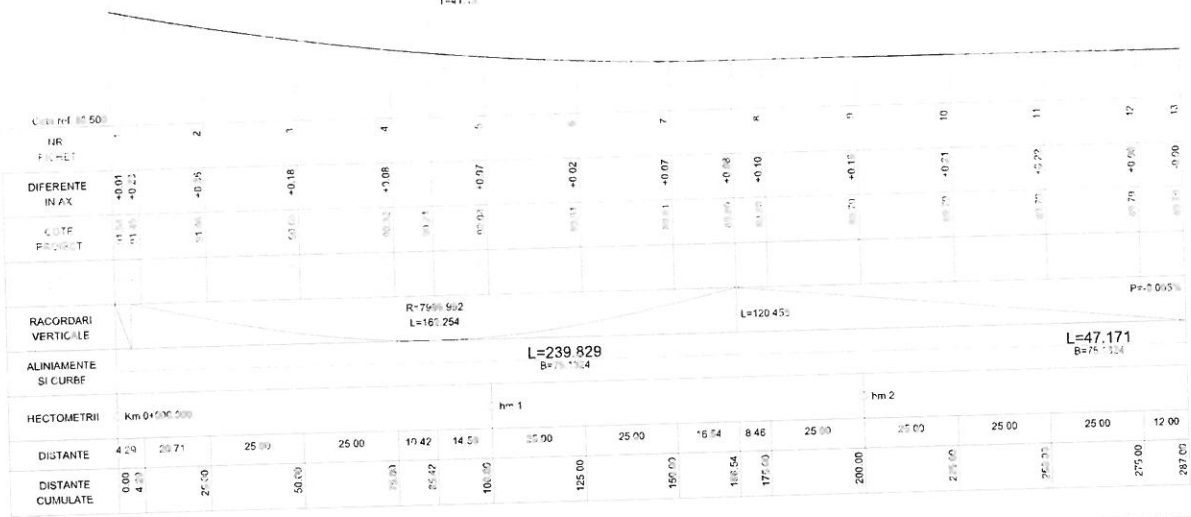

PROIECTANT GENERAL:	PROIECTANT DE SPECIALITATE:			
ING. TROBILY PENCEA	ING. ROBOLEA CRISTIAN			
ING. ROBOLEA CRISTIAN	ING. ROBOLEA CRISTIAN			
ING. ROBOLEA CRISTIAN	ING. ROBOLEA CRISTIAN			
Asfaltare si modernizare drumului de interes local, in comuna Deveselu, judetul Olt.				S.F.
Drum satesc Ds1395 - 1 - sat Deveselu				PL36

## PLAN DE SITUATIE Strada Tineretului - sat Deveselu

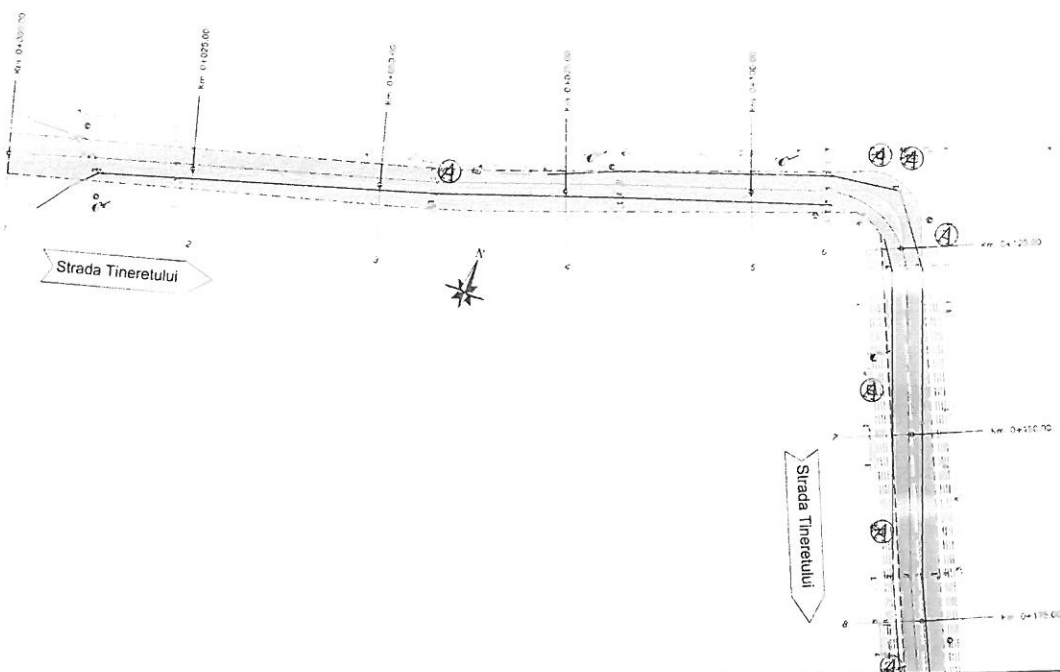

LEGENDA - elemente proiectate	LEGENDA - elemente existente
— limita carosabil proiectat	— drum
- · - · limita scuturament proiectat	— margine drum
— limita sant cu pământ proiectat	— margine trotuar
· · · · limita canal perete proiectat	— trotuar
podul tubului ø500, L=7.00m	— drum existent
limita perforatizabilitii	

PROIECTANT GENERAL	PROIECTANT DE SPECIALITATE	SCALA	DATA	PROIECT DE SITUATIE	PROIECT DE SITUATIE
ING. TUD OLT	ING. TUD OLT	1:100	Iulie 2019	ASFALTARE SI MODERNIZARE DRUMURI DE INTERES LOCAL, IN COMUNA DEVESELU, JUDEUL DOLJ	S.F.
ING. TUD OLT	ING. TUD OLT			PLAN DE SITUATIE	PS59
ING. TUD OLT	ING. TUD OLT			Strada Tineretului - sat Deveselu	

## PLAN DE SITUATIE Strada Tineretului - sat Deveselu

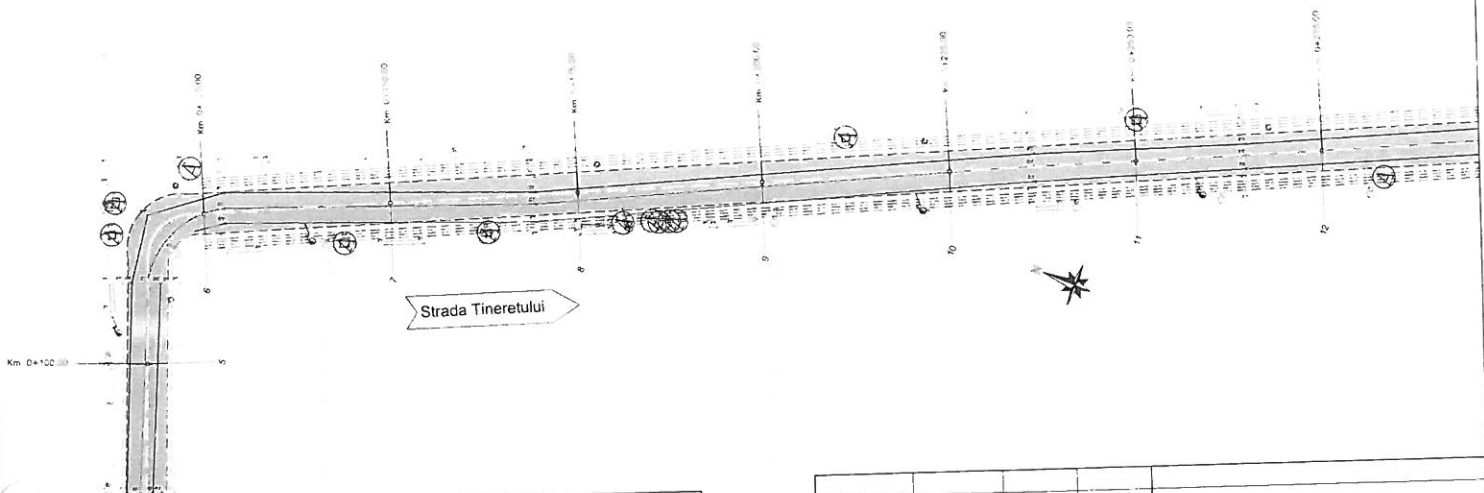

LEGENDA - elemente proiectate	LEGENDA - elemente existente
<p>----- limita carosabil proiectat</p> <p>----- linia de scolare proiectat</p> <p>----- linia sant de pamant proiectat</p> <p>----- linia sant de aer proiectat</p> <p>----- podet tubular #500, L=7,00m</p> <p>----- linia parte carosabila</p>	<p>----- Av. drum</p> <p>----- Margine drum</p> <p>----- Linia P.P. drum</p> <p>----- Tontax</p> <p>----- Stac. electic</p>

PROIECTANT GENERAL	PROIECTANT DE SPECIALITATE	SCURT	DATA	SCURT	DATA
ING. TRISTEL P. PETIC	ING. ROBERTO C. CILIAN	1:100	10/07/2019	1:100	10/07/2019
<p>PROIECT DE ASALTARE SI MODERNIZARE A DRUMURILOR DE INTERES LOCAL, IN COMUNA DEVESELU, JUDEUL DOLJ</p>		<p>PLAN DE SITUATIE</p>			
<p>Strada Tineretului - sat Deveselu</p>		<p>PS60</p>			

## PLAN DE SITUATIE Strada Tineretului - sat Deveselu

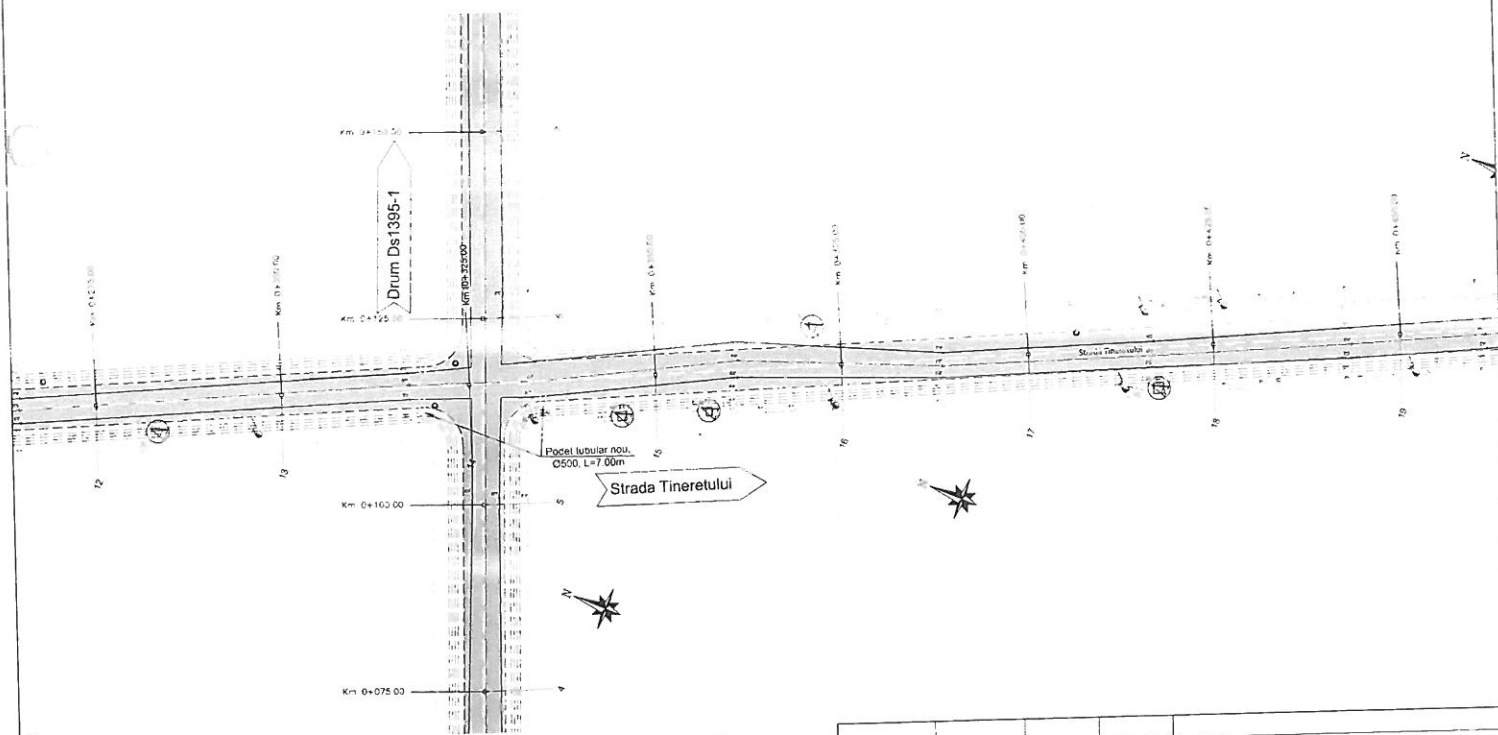

**LEGENDA - elemente proiectate**

- limita carosabil proiectat
- - - - - limita acostament proiectat
- limita sant de pamant proiectat
- - - - - limita sant de canal proiectat
- podet tubular Ø500, L=7.00m
- limita perete carosabil

**LEGENDA - elemente existente**

- drum
- margine drum
- canal
- podet

PROIECTANT GENERAL	PROIECTANT DE SPECIALITATE	SCALA	DATA	PROIECT DE SITUATIE
SCUD OLT	SCUD OLT	1:500	1970	ASALTARE SI MODERNIZARE DRUMURI DE INTERES LOCAL, IN COMUNA DEVESELU, JUDETUL OLT
ING. TRANDAFIR PETICU	ING. ROBERTO CRISTIAN			PLAN DE SITUATIE
ING. ROBERTO CRISTIAN	ING. ROBERTO CRISTIAN		1970	Strada Tineretului - sat Deveselu
				PS61

## PLAN DE SITUATIE Strada Tineretului - sat Deveselu

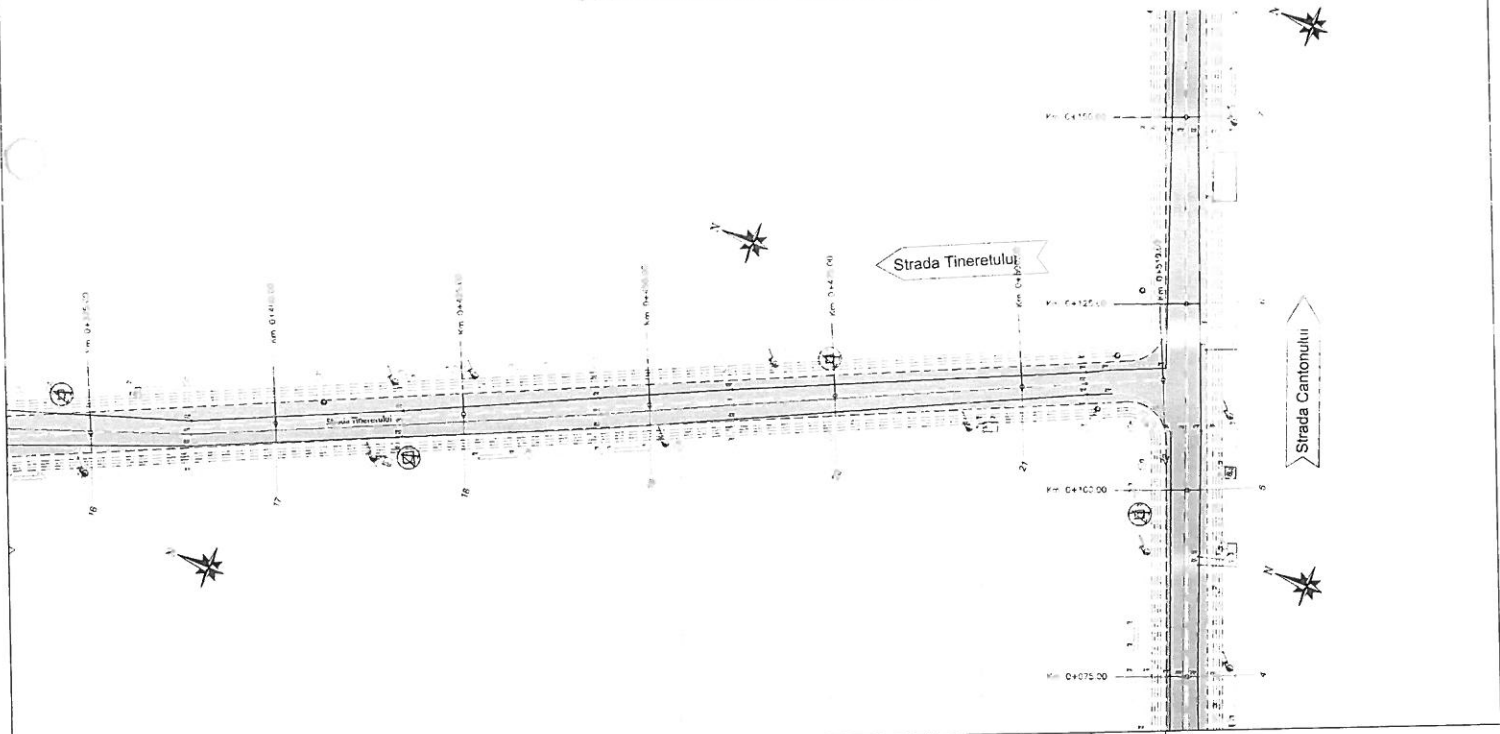

LEGENDA - elemente proiectate	LEGENDA - elemente existente
<p>----- limita carosabil proiectat</p> <p>----- limita acostament proiectat</p> <p>----- limita sani de pamant proiectat</p> <p>----- limita sara de sare proiectat</p> <p>podul tuburilor <math>\phi 500</math>, L=7,00m</p> <p>----- limita parca auto proiectat</p>	<p>----- Cale drum</p> <p>----- Margine drum</p> <p>----- Cale ingrijita/terata</p> <p>----- Limita</p> <p>----- Strada existentă</p>

PROIECTANT GENERAL	PROIECTANT DE SPECIALITATE	SCURT TITLU	SPECIALITATE	SCALA	DATA	SITUAȚIA	PROIECT
ING. TUDOR PETRESCU	ING. RADU CĂLĂBĂȘ	PROIECT DE ASALTARE SI MODERNIZARE DRUMURI DE INTERES LOCAL IN COMUNA DEVESELU, JUDEȚUL OLT	STRADA TINERETULUI	1:100	IULIE 2019	STRADA TINERETULUI	PS62

# PROFIL LONGITUDINAL Strada Tineretului - sat Deveselu

Km=0+15.09  
R=100.000  
L=21.43  
p=-0.74  
P=0.000  
h=0.42  
C=1.1  
T=1.15

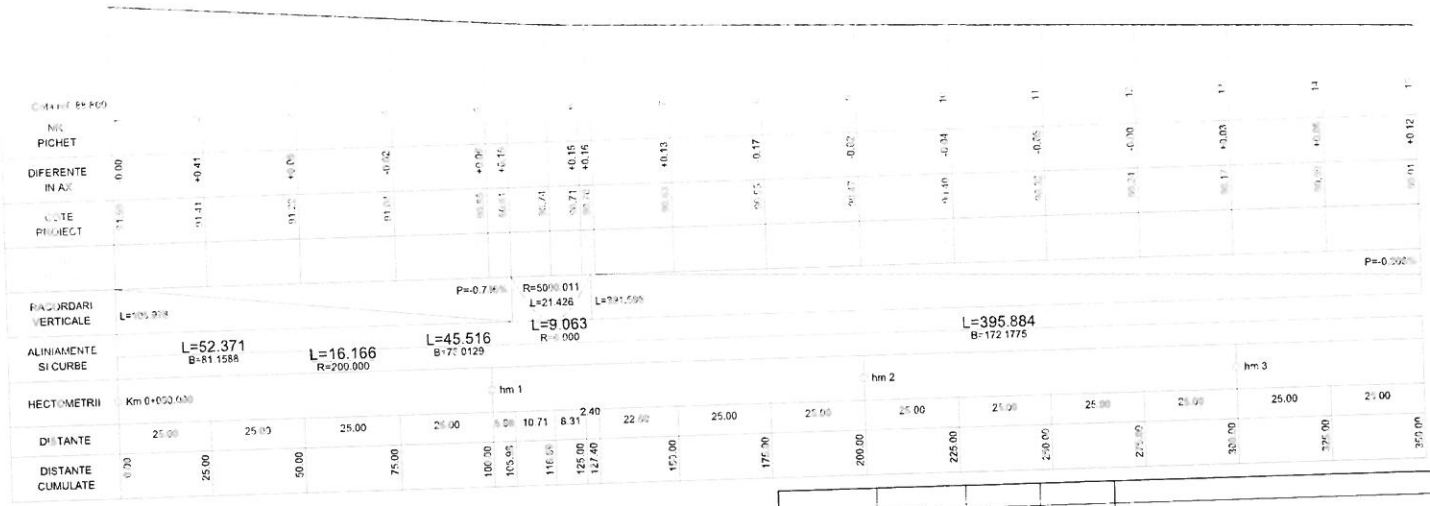

PROIECTANT GENERAL: ING. SUD OLT	PROIECTANT DE SPECIALITATE: ING. SUD OLT	SCALA: 1:100	REPERNAȚIE PERTIC. NR./CAT.
ING. TROAFĂ PETICA	ING. ROȘCĂȘA CĂLĂN	1:100	COM. NAȚIONALE DE PROIECTARE
ING. ROȘCĂȘA CĂLĂN	ING. ROȘCĂȘA CĂLĂN	Iulie 2019	Asfaltare și modernizare drumului de interes local, în comuna Deveselu, județul Olt.
ING. ROȘCĂȘA CĂLĂN	ING. ROȘCĂȘA CĂLĂN	Iulie 2019	Strada Tineretului - sat Deveselu.
			S.F. PL.37





## PLAN DE SITUATIE Strada Rozelor - sat Deveselu

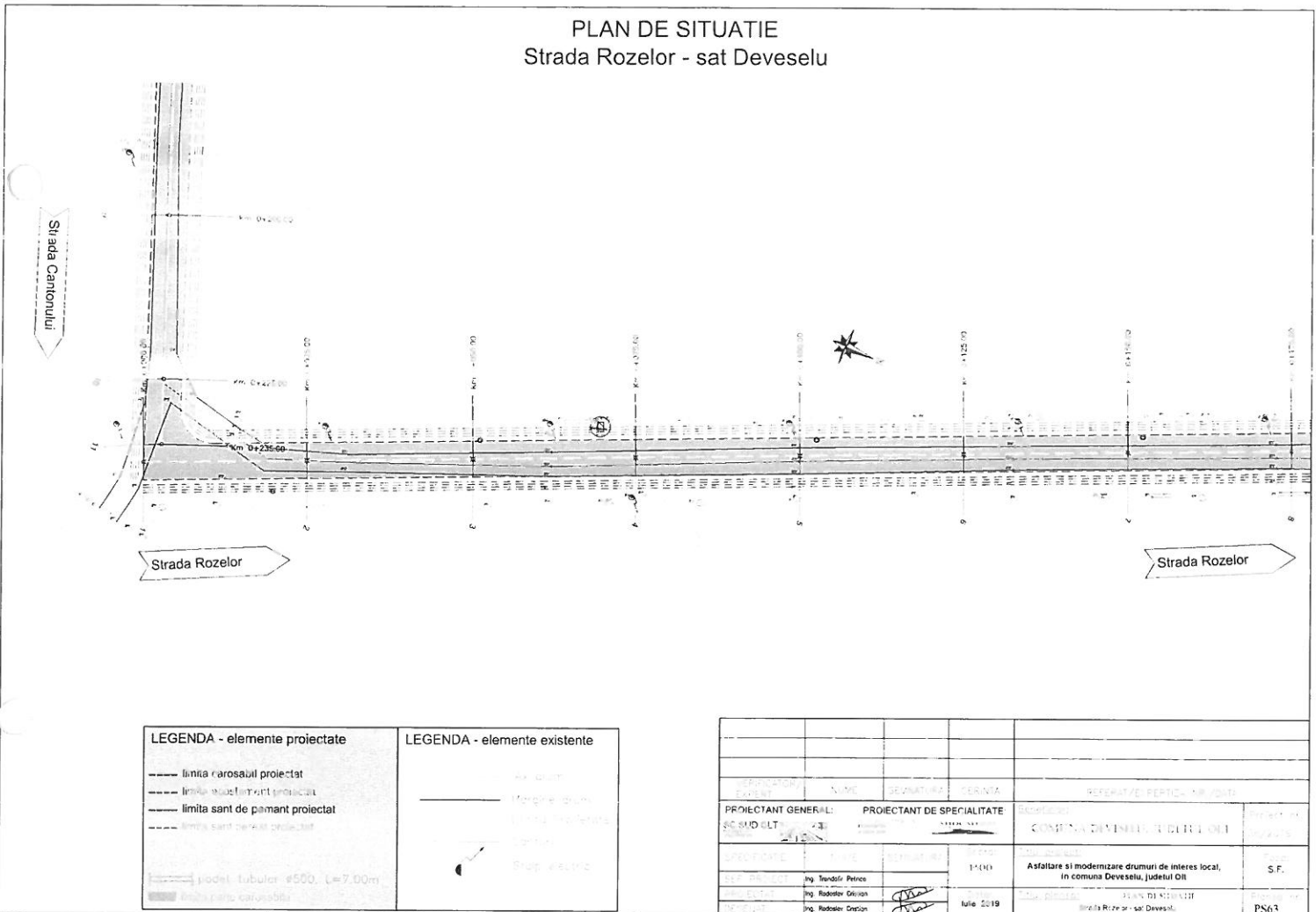

LEGENDA - elemente proiectate	LEGENDA - elemente existente
<ul style="list-style-type: none"> <li>--- limita carosabil proiectat</li> <li>--- limita asfaltament proiectat</li> <li>--- limita sant de pamant proiectat</li> <li>--- limita sant de canaliz proiectat</li> </ul>	<ul style="list-style-type: none"> <li>--- asfalt</li> <li>--- margine drum</li> <li>--- limita asfaltament existent</li> <li>--- sant</li> <li>--- strop electric</li> </ul>
<ul style="list-style-type: none"> <li>--- podet tubular ø500, L=7.00m</li> <li>--- canalizare</li> </ul>	

PROIECTANT GENERAL:	PROIECTANT DE SPECIALITATE	RECEPȚIA	REFERINȚE PERTINENTE:
SC SUD-EST	SC SUD-EST	14/09	COMUNA DEVESELU, JUDEȚUL OLT
ING. SANDU PETRE	ING. ROȘOIU GELIUȘ	14/09	Asfaltare și modernizare drumuri de interes local, în comuna Deveselu, județul Olt
ING. ROȘOIU GELIUȘ	ING. ROȘOIU GELIUȘ	14/09	PLAN DE SITUATIE
ING. ROȘOIU GELIUȘ	ING. ROȘOIU GELIUȘ	14/09	Strada Rozelor - sat Deveselu
			PS63



## PLAN DE SITUATIE Strada Rozelor - sat Deveselu

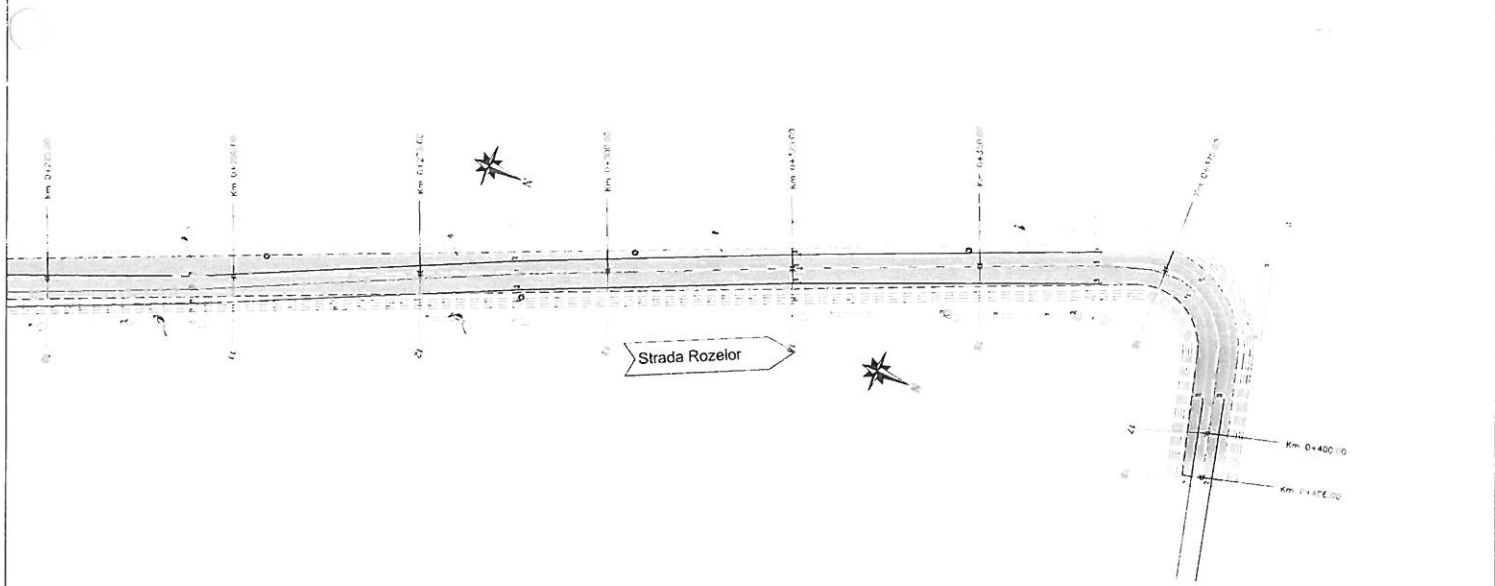

LEGENDA - elemente proiectate	LEGENDA - elemente existente
<ul style="list-style-type: none"> <li>— limita carosabil proiectat</li> <li>— limita trotuar proiectat</li> <li>— limita sant de pamant proiectat</li> <li>— limita sant perimetru proiectat</li> </ul>	<ul style="list-style-type: none"> <li>— drum</li> <li>— Margine drum</li> <li>— Limita sant pamant</li> <li>— Limita sant</li> <li>— Sfant. uscat</li> </ul>
<ul style="list-style-type: none"> <li>pedel tubular #500, L=7.00m</li> <li>limita panta carosabila</li> </ul>	

CANTON	NUME	SEMNATURA	CERANTA	REFERINTE FORTIC. NR. CALD.
PROIECTANT GENERAL:		PROIECTANT DE SPECIALITATE		Beneficiar
ING. CUD OLT		ING. ROBERTO DRISAN		COMUNA DEVESELU, JUDETEL DE BUCURESTI
ASPECT DATE	NR. PLAN	DATA PLAN	17.09	Astolare si modernizare drumuri de interes local. In comuna Deveselu, judetul DE BUCURESTI
PROIECTANT	ING. ROBERTO DRISAN	SEMNATURA	17.09	PROIECTANT
PROIECTANT	ING. ROBERTO DRISAN	SEMNATURA	17.09	PROIECTANT
				SCALA: 1:1000
				Strada Rozelor - sat Deveselu
				PS65

## PROFIL LONGITUDINAL Strada Rozelor - sat Deveselu

Km=0+000.00  
 R=2000.00  
 L=15.940  
 p1=-0.33  
 p2=+0.50  
 q=0.02  
 B=16  
 T=2.10

Km=0+276.00  
 R=5000.00  
 L=50.021  
 p1=+0.30  
 p2=+0.25  
 q=0.05  
 B=14.1  
 T=1.8

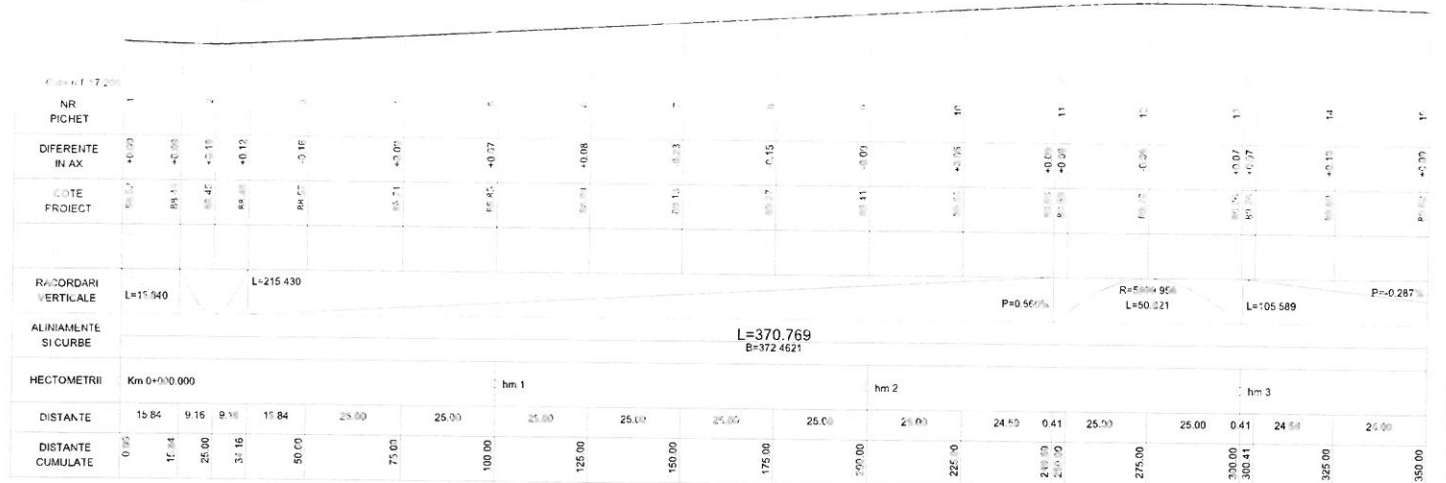

PROIECTANT GENERAL	PROIECTANT DE SPECIALITATE	REDACTOR	REVISOR	COORDONATOR PROIECT	NR. FOI
SC SUD OLT	ING. ROBERTO CRISTIAN	ING. TRANDAFIR PETRESCU	ING. ROBERTO CRISTIAN	ING. ROBERTO CRISTIAN	1/01
SCOPUL PROIECTULUI: <b>Asfaltare si modernizare drumuri de interes local, in comuna Deveselu, judetul Olt</b>				S.F.	
DATA PROIECTULUI: Iulie 2019				STRADA ROZELOR - SAT DEVESELU, PL39	







PROFIL TRANSVERSAL TIP 7

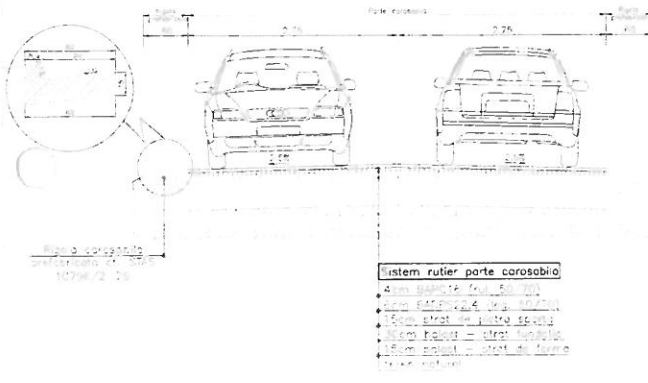

PROFIL TRANSVERSAL TIP 8

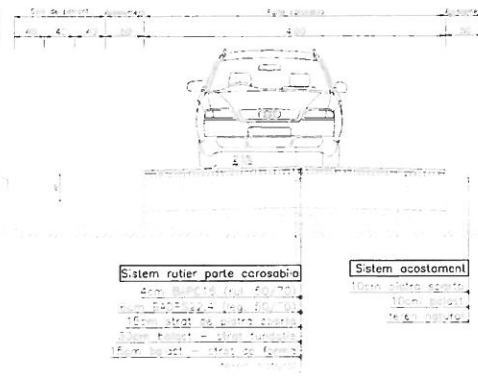

PROFIL TRANSVERSAL TIP 9

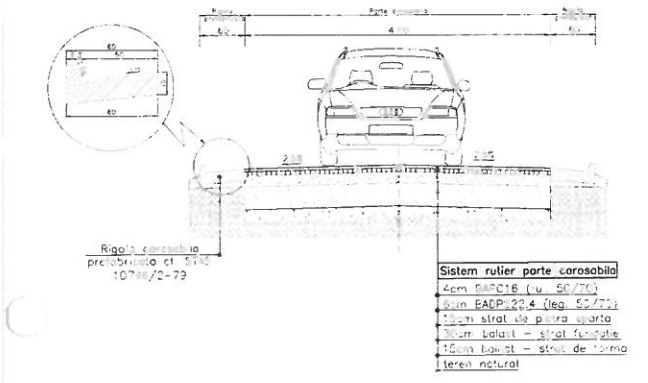

Nr. Crl.	Sat.	Denumire strada	Profil transversal tip
1		Drum comunal 217 (1)	PTT 1
2		Strada Dumbrava	PTT 3
3		Strada Galatie	PTT 1
4		Drum satenic 1219	PTT 4
5		Strada Lufeni (1)	PTT 1
6		Strada Maroniului Est	PTT 1
7		Strada Ilanului Vest	PTT 1
8		Strada Muresului	PTT 1
9		Strada Prichienii	PTT 1
10		Strada Traian Vuia	PTT 1
11		Strada Polsoara Noua	PTT 2
12		Strada Tarnabii	PTT 1
13		Strada Valina Lunga	PTT 1
14		Strada Avulului	PTT 10
15		Avenia si parcare	PTT 11
16		Strada satenic 1219-1	PTT 1
17		Strada Barzului (1) - parte la strada Vaslui	PTT 8
18		Strada Barzului (1) - strada Maroniului - strada Sarghii (1) (1)	PTT 8
19		Strada Galatiei	PTT 1
20		Strada Galatiei	PTT 1
21		Strada Iancu Juma	PTT 1
22		Strada Kiazului	PTT 1
23		Strada Pasaiei Muncii	PTT 5
24		Strada Morii	PTT 2
25		Strada Pogorarii Pinarului	PTT 7
26		Strada Ploinii	PTT 1
27		Strada Rozelor	PTT 1
28		Strada Sarghii (1) (1)	PTT 9
29		Strada Timerei	PTT 7
30		Strada Valer	PTT 1

PROIECTANT GENERAL:	PROIECTANT DE SPECIALITATE:	SCURT TITLU:	COMUNA DIVESELU, JUDEUL OLI
Ing. Transilvia Peluce	Ing. Rodolphe Cristion	100	Asfaltare si modernizare drumuri de interes local, in comuna Deveselu, judetul OI
Ing. Rodolphe Cristion	Ing. Rodolphe Cristion	100	Asfaltare si modernizare drumuri de interes local, in comuna Deveselu, judetul OI
Ing. Rodolphe Cristion	Ing. Rodolphe Cristion	100	Asfaltare si modernizare drumuri de interes local, in comuna Deveselu, judetul OI



PROFIL TRANSVERSAL TIP 10

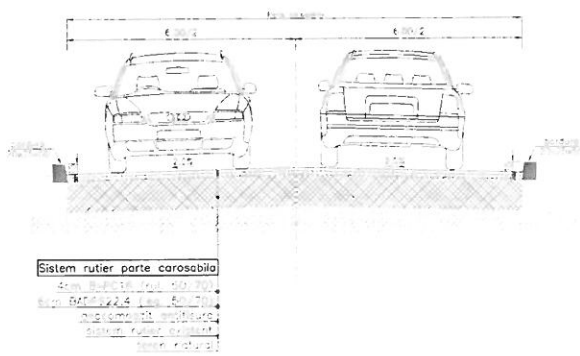

PROFIL TRANSVERSAL TIP 11

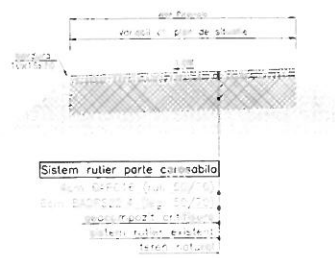

VERIFICATOR	PROIECTANT	DEZINATATOR	DIRIGINTA	REFERINTE PERIUS /R /DATA
PROIECTANT GENERAL:	PROIECTANT DE SPECIALITATE:	SPECIALITATE		
SC SUD-ILT	ING. TRANDAFIR PETRICA	COMUNA DIVISELU, JUDEULUI OLT		
SC SUD-ILT	ING. ROZALIV CRISTIAN	Asfaltare si modernizare drumului de interes local, in comuna Diviselu, judetul Olt		
SC SUD-ILT	ING. ROZALIV CRISTIAN	PROFIL TRANSVERSAL TIP		
		PTI 04		

PLAN COFRAJ

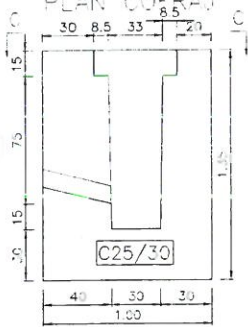

PLAN ARMARE RIGOLA DREPTUNGIULARA DIN BETON

SECTIUNE B-B

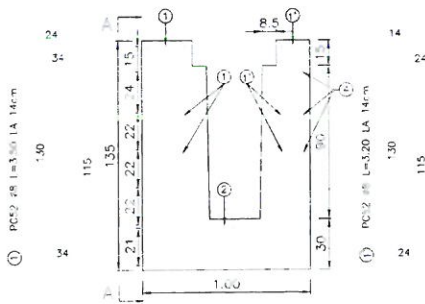

① PC52 ø8 L=3.50 LA 14cm

② PC52 ø8 L=3.20 LA 14cm

③ PC52 ø8 L=2.90 LA 14cm

④ Agrafe 12ø6 L=0.45

⑤ Agrafe 12ø6 L=0.35

SECTIUNE A-A

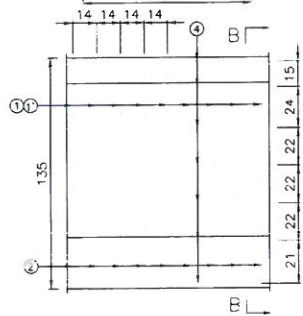

⑥ OB37 32ø8 L/ml=1.00

EXTRAS DE ARMATURA PENTRU 1 METRU LINIAR DE RIGOLA DREPTUNGIULARA DIN BETON

M	ø(mm)	n(buc)	L(m)	Lungimi pe diametre	
				ØB37	PC52
1	8	6	3.50	Ø8	Ø8
2	8	6	3.20	Ø8	Ø8
3	8	6	2.90	Ø8	Ø8
4	8	6	2.50	Ø8	Ø8
5	8	6	2.10	Ø8	Ø8
6	8	6	1.70	Ø8	Ø8
7	8	6	1.30	Ø8	Ø8
8	8	6	0.90	Ø8	Ø8
9	8	6	0.50	Ø8	Ø8
10	8	6	0.10	Ø8	Ø8
11	8	6	0.00	Ø8	Ø8
12	8	6	0.00	Ø8	Ø8
13	8	6	0.00	Ø8	Ø8
14	8	6	0.00	Ø8	Ø8
15	8	6	0.00	Ø8	Ø8
16	8	6	0.00	Ø8	Ø8
17	8	6	0.00	Ø8	Ø8
18	8	6	0.00	Ø8	Ø8
19	8	6	0.00	Ø8	Ø8
20	8	6	0.00	Ø8	Ø8
21	8	6	0.00	Ø8	Ø8
22	8	6	0.00	Ø8	Ø8
23	8	6	0.00	Ø8	Ø8
24	8	6	0.00	Ø8	Ø8
25	8	6	0.00	Ø8	Ø8
26	8	6	0.00	Ø8	Ø8
27	8	6	0.00	Ø8	Ø8
28	8	6	0.00	Ø8	Ø8
29	8	6	0.00	Ø8	Ø8
30	8	6	0.00	Ø8	Ø8
31	8	6	0.00	Ø8	Ø8
32	8	6	0.00	Ø8	Ø8
33	8	6	0.00	Ø8	Ø8
34	8	6	0.00	Ø8	Ø8
35	8	6	0.00	Ø8	Ø8
36	8	6	0.00	Ø8	Ø8
37	8	6	0.00	Ø8	Ø8
38	8	6	0.00	Ø8	Ø8
39	8	6	0.00	Ø8	Ø8
40	8	6	0.00	Ø8	Ø8
41	8	6	0.00	Ø8	Ø8
42	8	6	0.00	Ø8	Ø8
43	8	6	0.00	Ø8	Ø8
44	8	6	0.00	Ø8	Ø8
45	8	6	0.00	Ø8	Ø8
46	8	6	0.00	Ø8	Ø8
47	8	6	0.00	Ø8	Ø8
48	8	6	0.00	Ø8	Ø8
49	8	6	0.00	Ø8	Ø8
50	8	6	0.00	Ø8	Ø8
51	8	6	0.00	Ø8	Ø8
52	8	6	0.00	Ø8	Ø8
53	8	6	0.00	Ø8	Ø8
54	8	6	0.00	Ø8	Ø8
55	8	6	0.00	Ø8	Ø8
56	8	6	0.00	Ø8	Ø8
57	8	6	0.00	Ø8	Ø8
58	8	6	0.00	Ø8	Ø8
59	8	6	0.00	Ø8	Ø8
60	8	6	0.00	Ø8	Ø8
61	8	6	0.00	Ø8	Ø8
62	8	6	0.00	Ø8	Ø8
63	8	6	0.00	Ø8	Ø8
64	8	6	0.00	Ø8	Ø8
65	8	6	0.00	Ø8	Ø8
66	8	6	0.00	Ø8	Ø8
67	8	6	0.00	Ø8	Ø8
68	8	6	0.00	Ø8	Ø8
69	8	6	0.00	Ø8	Ø8
70	8	6	0.00	Ø8	Ø8
71	8	6	0.00	Ø8	Ø8
72	8	6	0.00	Ø8	Ø8
73	8	6	0.00	Ø8	Ø8
74	8	6	0.00	Ø8	Ø8
75	8	6	0.00	Ø8	Ø8
76	8	6	0.00	Ø8	Ø8
77	8	6	0.00	Ø8	Ø8
78	8	6	0.00	Ø8	Ø8
79	8	6	0.00	Ø8	Ø8
80	8	6	0.00	Ø8	Ø8
81	8	6	0.00	Ø8	Ø8
82	8	6	0.00	Ø8	Ø8
83	8	6	0.00	Ø8	Ø8
84	8	6	0.00	Ø8	Ø8
85	8	6	0.00	Ø8	Ø8
86	8	6	0.00	Ø8	Ø8
87	8	6	0.00	Ø8	Ø8
88	8	6	0.00	Ø8	Ø8
89	8	6	0.00	Ø8	Ø8
90	8	6	0.00	Ø8	Ø8
91	8	6	0.00	Ø8	Ø8
92	8	6	0.00	Ø8	Ø8
93	8	6	0.00	Ø8	Ø8
94	8	6	0.00	Ø8	Ø8
95	8	6	0.00	Ø8	Ø8
96	8	6	0.00	Ø8	Ø8
97	8	6	0.00	Ø8	Ø8
98	8	6	0.00	Ø8	Ø8
99	8	6	0.00	Ø8	Ø8
100	8	6	0.00	Ø8	Ø8

Nota:  
- Lungimea barei marca Ø se stabileste pe contier

EXTRAS DE ARMATURA PENTRU 1 METRU LINIAR DE RIGOLA

Ø	n	L	L	L	L	L	L
Ø8	6	3.50	3.20	2.90	2.50	2.10	1.70
Ø8	6	3.20	2.90	2.50	2.10	1.70	1.30
Ø8	6	2.90	2.50	2.10	1.70	1.30	0.90
Ø8	6	2.50	2.10	1.70	1.30	0.90	0.50
Ø8	6	2.10	1.70	1.30	0.90	0.50	



DETALII DE EXECUTIE LA PODETE DALATE

DETALIU EXECUTIE TIMPAN MONOLIT  
DETALIU MONTARE DALE PE ELEVATII CULEE  
Sc.1:20

SECTIUNE 2 - 2  
Sc.1:100

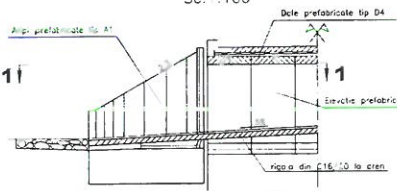

SECTIUNE 1 - 1  
Sc.1:100

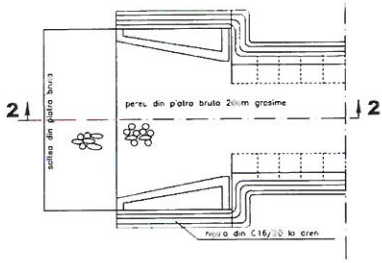

NOTA:  
Panta minima a drenului va fi de 5‰.

DETALIU DE PEREERE  
FUNDATII INDEPENDENTE  
Sc.1:25

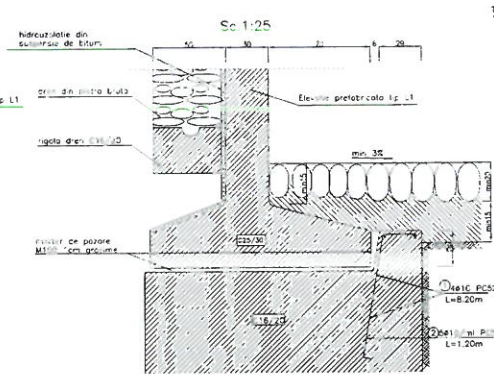

EXTRAS DE ARMATURA

ELEMENTE DE NERUBREA SI BUCATI ATEMENA	MARCA	DIAMETRU (mm)	NR BARELOR ATEMENA		LUNGIMEA IN METRI A UNEI BARE	PC 52	
			TOTUL ELEMENTE	INTOATE ELEMENTELE		LUNGIMEA IN METRI PE DIAMETRU PT BARELE DIN TOATE ELEMENTELE	DIAMETRU
1	A5	10	2	72	1.45	84.00	
2	A5	10	2	50	1.45	72.00	
3	A5	10	2	50	1.45	72.00	7.00
4	A5	10	2	50	1.45	72.00	
5	A5	10	2	50	1.45	72.00	
TOTAL LUNGIMI PE DIAMETRU (m)						272.00	27.00
MASA PE METRU (kg)						0.617	2.40
MASA PE DIAMETRU (kg)						169.13	68.56
MASA TOTALA PE TIPURI DE OTEL (kg)							214.71

CARACTERISTICI PENTRU O FUNDATIE

COFRAJ: 35MP  
OTEL BETON: PC 52  
ACOPERIRE CU BETON: 5cm  
VOLUM BETON C25/30: 19.5mc

CARACTERISTICI PENTRU UN TIMPAN

COFRAJ: 5MP  
OTEL BETON: PC 52  
ACOPERIRE CU BETON: 5cm  
VOLUM BETON C25/30: 1.0mc

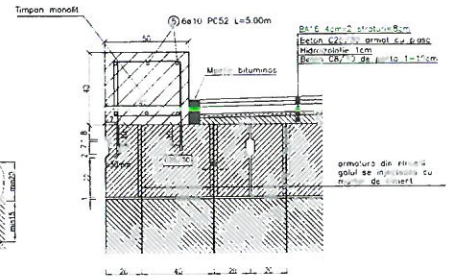

2x3920/ml PC52 L=0.45m  
NOTA: Marca de incalzire 10cm in casa B4 prin rasina epoxidica

PROIECTANT GENERAL:	PROIECTANT DE SPECIALITATE:	REPERAT/EXPERIENTA NR./DATA:	PROIECTANT:
Ing. Todorik Petric	Ing. Todorik Petric	Asfaltare si modernizare drumuri de interes local in comuna Davesoleu, judetul Olt	S.F.
Ing. Radu Crisan	Ing. Radu Crisan		
Ing. Radu Crisan	Ing. Radu Crisan		
Luna 2019			
DETALII DE EXECUTIE LA PODETE DALATE			

